



PRODUCT CATALOG



VOLUME 24

Made in Michigan



Get quote >>

Angic Global Solutions

1-888-872-0690

<https://www.AngicGlobal.com> Sales@AngicGlobal.com



ANGIC
www.angic.com

Get quote 

Angic Global Solutions 1-888-872-0690
<https://www.AngicGlobal.com> Sales@AngicGlobal.com

Terminal Terminology

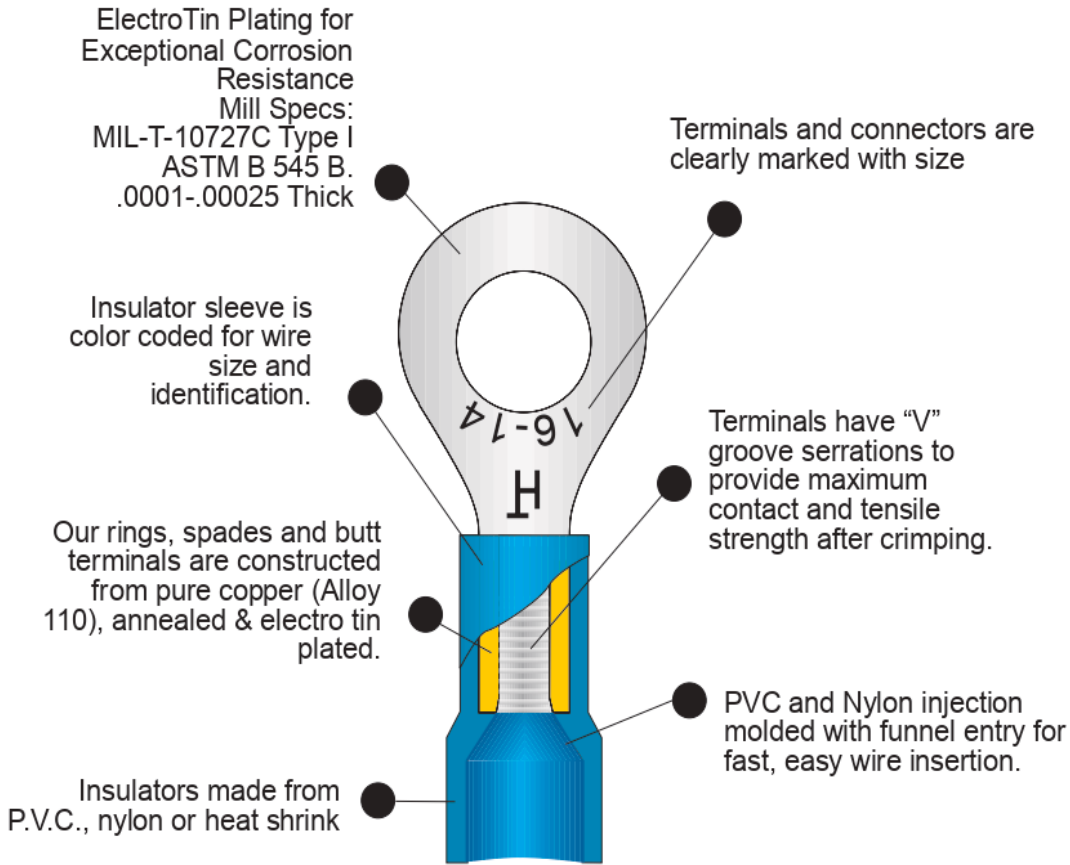

Recognizing Terminal Types

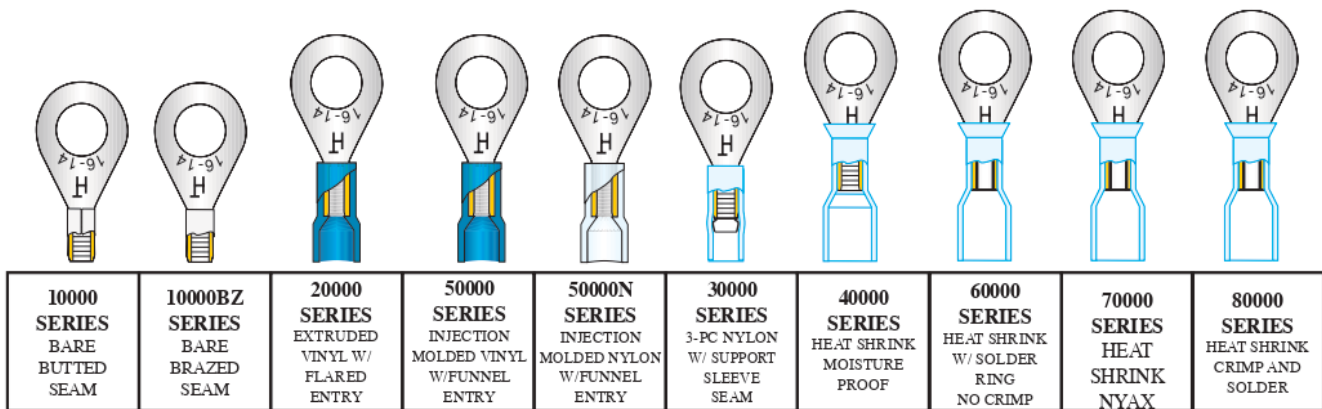
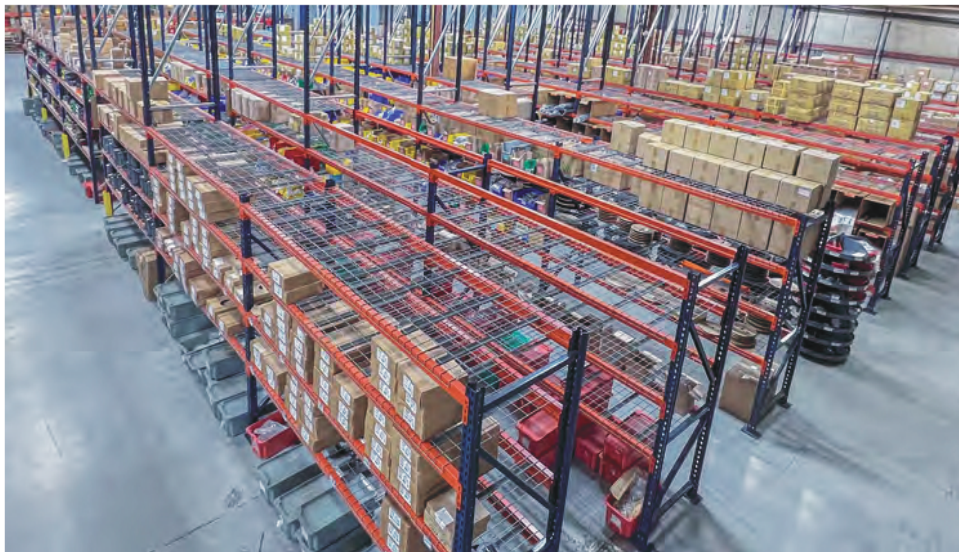
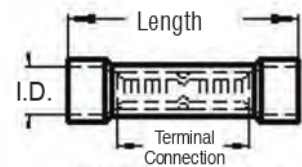
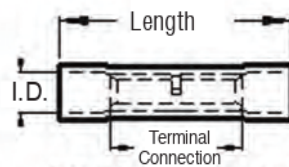
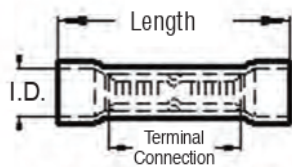
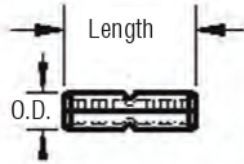

Table of Contents

3 and 4 Way Connectors	24	High Temp. Terminals	18-19
Accessories	40	Hooks	16
Adapters	44	IDC & Miscellaneous	36-37
Battery Cables	34	Instant Tap Connectors.....	37
Battery Covers.....	33	Kits.....	31, 46-47
Battery Terminals.....	33	Mylar Tape Products.....	45
Brazed Seam Terminals	17	Nylon/Steel Clamps.....	40
Bullet Connectors	23	Parallel Connectors	44
Butt Connectors.....	5-7	Piggybacks	19
Cable Ties & Accessories	34	Pin Terminals.....	25
Crimp Caps.....	11	Quick Disconnects.....	20-22
Split Loom & Spiral Wraps.....	39	Rings	8-11
Closed End Connectors.....	10	Screw On Connectors	36
Ferrule Wire Ends.....	44	Spades	12-15
Flags.....	25	Tape.....	45
Fuses, Fuse Holders	38-39	Tools	40-43
Fuse Pullers.....	38	T-Tap Connectors	37
Heat Shrink Terminals	26-29	Wire	35
Heat Shrink Tubing	30-31	Wire Processing	45
Heavy Duty Electrical Lugs.....	32		



Butt Connectors



L = Length
 M = Material Thickness

Vinyl Insulated Butted Seam Butt Connector Shown

Extruded Nylon Insulated Seamless or Butted Seam Butt Connector

Molded Nylon Insulated Seamless or Butted Seam Butt Connector

Bare Butted Seam

Wire Size	Part No.	L	O.D.	M
22-18	10080*	.560	.133/.135	.028
	10080E	.560	.112/.115	.020

16-14	10170*	.560	.152/.156	.030
	10170E	.560	.134/.135	.020

12-10	10310*	.625	.212/.215	.035
	10310E	.625	.208/.210	.030

Bare Seamless

26-24	12403	.475	.084	.018
-------	-------	------	------	------

22-18	10083	.565	.133/.135	.030
	10083L	.625	.133/.135	.030

16-14	10173	.565	.152/.156	.030
	10173L	.630	.152/.156	.030
	10173XL	.665	.152/.156	.030

12-10	10313	.625	.212/.215	.035
	10313L	.810	.212/.215	.035

8	10624	.827	.273/.275	.049
---	-------	------	-----------	------

6	10625	1.030	.350/.352	.058
---	-------	-------	-----------	------

4	10626	1.140	.438/.440	.070
---	-------	-------	-----------	------

2	10627	1.250	.512/.514	.072
---	-------	-------	-----------	------

22-18	11082CC	U/I Seamless Window Butt		
-------	---------	--------------------------	--	--

16-14	11172CC	U/I Seamless Window Butt		
-------	---------	--------------------------	--	--

12-10	11312CC	U/I Seamless Window Butt		
-------	---------	--------------------------	--	--

Vinyl Insulated

Wire Size	Part No.	L	Terminal	I.D.
22-18	20080*	.970	10080	.160
	20080E	.970	10080E	.160

16-14	20170*	.970	10170	.180
	20170E	.970	10170E	.180

12-10	20310*	1.060	10310	.235
	20310E	1.060	10310E	.235

Vinyl - Seamless

22-18	20080SV	.970	10083	.160
-------	---------	------	-------	------

16-14	20170SV	.970	10173	.185
-------	---------	------	-------	------

12-10	20310SV	1.060	10313	.235
-------	---------	-------	-------	------

8	20624	1.460	10624	.320
---	-------	-------	-------	------

6	20625	1.740	10625	.395
---	-------	-------	-------	------

4	20626	1.930	10626	.500
---	-------	-------	-------	------

2	20627	2.250	10627	.560
---	-------	-------	-------	------



Get quote >>

Angic Global Solutions

1-888-872-0690

<https://www.AngicGlobal.com> Sales@AngicGlobal.com

Nylon Straight Butted Seam

Wire Size	Part No.	L	Terminal	I.D.
22-18	20081	.990	10080	.135
	20081E	.990	10080E	.135
.....				
16-14	20171	.990	10170	.155
	20171E	.990	10170E	.155
.....				
12-10	20311	1.070	10310	.205
	20311E	1.070	10310E	.205

Nylon Flared Butted Seam

22-18	50081	.985	10080	.165
	50081E	.985	10080E	.165
.....				
16-14	50171	.985	10170	.195
	50171E	.985	10170E	.195
.....				
12-10	50311	1.070	10310	.270
	50311E	1.070	10310E	.270

Nylon Flared Seamless

22-18	20083	.985	10083	.165
.....				
16-14	20173	.985	10173	.195
.....				
12-10	20313	1.070	10313	.270

Nylon Straight Seamless

26-24	22403#	.757	12403	.080
.....				
22-18	20083S 20083LN	.990 1.06	10083 10083L	.135 .135
.....				
16-14	20173S 20173LN 20173XLN	.990 1.06 1.06	10173 10173L 10173XL	.155 .155 .155
.....				
12-10	20313S 20313LN	1.070 1.25	10313 10313L	.205 .205

8	20624N	1.500	10624	.260
---	--------	-------	-------	------

6	20625N	1.780	10625	.340
---	--------	-------	-------	------

4	20626N	1.980	10626	.430
---	--------	-------	-------	------

4 Pc Nylon w/ Sleeve

22-18	30080	1.00	10080	.135
.....				
16-14	30170	1.00	10170	.155
.....				
12-10	30310	1.20	10310	.205
.....				
			3 PC TOOL	20717



Cool Seal Nylon Butts

22-18	29083	1.00		
.....				
16-14	29173	1.00		
.....				
12-10	29313	1.20		

*Seals Out
Moisture
Causing
Corrosion.
A Heat-Less/
Solderless
Connection.*

Step Down Butts

Bare Seamless Step Down Butts

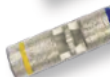
Wire Size	Part No.	Insulation Color & Stripe
26-24 to 22-18	10315	w/26-24 white & 22-18 red stripe
16-14 to 22-18	10316	w/22-18 red & 16-14 blue stripe
12-10 to 16-14	10317	w/16-14 blue & 12-10 yellow stripe
8 to 12-10	10318CC	w/12-10 yellow & red 8 ga stripe
6 to 8	10319	w/ 6 ga blue & 8 ga red stripe
12-10 to 22-18	10320	w/ 12-10 yellow & 22-18 red stripe
8 to 16-14	10321	w/ 8 ga red & 16-14 blue stripe
26-24 to 22-18	11315CC	U/I S/D Window 
16-14 to 22-18	11316CC	U/I S/D Window Butt 
12-10 to 16-14	11317CC	U/I S/D Window 

Nylon/Vinyl Step Down

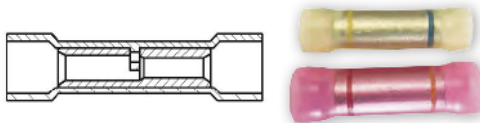

22-18 to 26-24	20315	red w/22-18 & 26-24 white stripe
16-14 to 22-18	20316 20316N	blue w/22-18 red & 16-14 blue stripe
12-10 to 16-14	20317 20317N	yellow w/16-14 blue & 12-10 yellow stripe
8 to 12-10	20318 20318N	red w/12-10 yellow & red 8 ga stripe
6 to 8	20319#	blue w/ red stripe
12-10 to 22-18	20320	yellow w/ red 12-10 / 22-18 ga
8 to 16-14	20321#	red w/ blue 8 ga / 16-14 ga

Heat Shrink Step Down

22-18 to 26-24	40315	white w/ 26-24 & 22-18 red stripe
16-14 to 22-18	40316	blue w/22-18 red & 16-14 blue stripe
12-10 to 16-14	40317	yellow w/16-14 blue & 12-10 yellow stripe
8 to 12-10	40318	red w/ 12-10 yellow & red 8 ga stripe

Heat Shrink Step Down - NYAX

16-14 to 22-18	70316	blue w/22-18 red & 16-14 blue stripe
12-10 to 16-14	70317	yellow w/16-14 blue & 12-10 yellow stripe
8 to 12-10	70318	red w/12-10 yellow & 8 red stripe

Vinyl - Oval Butt

Wire Size	Part No.	L	Terminal	I.D.
16-14	20174	.960	10170	.180



Nylon - Moisture Resistant

22-18	30080G	1.04	-	.145
16-14	30170G	1.04	-	.170
12-10	30310G	1.25	-	.250



Heat Shrink Over Nylon

22-18	42083	1.800	20083S	.180
16-14	42173	1.800	20173S	.250
12-10	42313	2.000	20313S	.325



Heat Shrink - Polyolefin 2.5 Ratio

26-22	40024	1.00	12403	.125
22-18	20082# 20082L	1.500 1.500	10083 10083L	.165 .165
16-14	20172# 20172L	1.500 1.500	10173 10173L	.196 .196
12-10	20312#	1.700	10313L	.250
8	40624	1.800	10624	.312
6	40625		* Sold Unassembled (Part# 10625 & 284)	



Heat Shrink - NYAX

22-18	40082 40082L	1.250 1.500	10083 10083L	.200 .200
16-14	40172 40172L	1.250 1.500	10173 10173L	.250 .250
12-10	40312 40312L	1.500 1.750	10313 10313L	.280 .280



Bare Butted Seam

Wire Size	Stud Size	Part No.
4		10014
6		10020*
6 .187 Barrel		10020E
6 Slim		10021
6 Slim .187 Barrel		10021E
8		10030*
8 Slim		10038
8 Slim .187 Barrel		10038E
10		10040*
10 .187 Barrel		10040E
1/4		10041*
1/4 Slim		10044+
1/4 Slim .187 Barrel		10044E
5/16		10042*
5/16 .187 Barrel		10042E
3/8		10043+
1/2		10204

22-18

4		10084
6		10086*
6 .187 Barrel		10086E
6 Slim		10085
8		10090*
8 Slim		10098
8 Slim .187 Barrel		10098E
10		10100*
10 .187 Barrel		10100E
1/4		10101*
1/4 Slim		10114+
1/4 Slim .187 Barrel		10114E
5/16		10102*
5/16 .187 Barrel		10102E
5/16 Wide .558		10106
3/8		10103*
1/2		10104+

16-14

4		10205
6		10210*
6 Slim		10215
8		10220*
8 Slim		10225
10		10230*
1/4		10240*
1/4 Slim		10245*
5/16		10250*
3/8		10260*
1/2		10233*
*1/2 Wide		10235#

12-10

Long Neck Bare Brazed

8		10030LBZ#
10		10040LBZ#

22-18

8		10090LBZ#
10		10100LBZ#

16-14

10		10230LBZ#
----	--	-----------

12-10

Bare Brazed Seam

4		12404#
6		12406#
8		12408#
10		12410#

24-20

MORE SIZES ADDED

Bare Brazed Seam (cont.)

Wire Size	Stud Size	Part No.
4		10014BZ
6		10020BZ*
6 Slim		10021BZ
8		10030BZ*
8 Slim		10038BZ
10		10040BZ*
10 .187 Barrel		10040EBZ
1/4		10041BZ*
1/4 Slim		10044BZ+
1/4 Slim .187 Barrel		10044EBZ
5/16		10042BZ*
3/8		10043BZ+
1/2		10204BZ

22-18

4		10084BZ
6		10086BZ*
6 .187 Barrel		10086EBZ
6 Slim		10085BZ
8		10090BZ*
8 Slim		10098BZ
8 Slim .187 Barrel		10098EBZ
10		10100BZ*
10 .187 Barrel		10100EBZ
1/4		10101BZ*
1/4 Slim		10114BZ+
1/4 Slim .187 Barrel		10114EBZ
5/16		10102BZ*
3/8		10103BZ*
1/2		10104BZ+

16-14

6		10210BZ*
6 Slim		10215BZ
8		10220BZ*
8 Slim		10225BZ
10		10230BZ*
1/4		10240BZ*
1/4 Slim		10245BZ*
5/16		10250BZ*
3/8		10260BZ*
1/2		10233BZ*

12-10

8		10608#
10 Slim		10609#
10		10610#
1/4		10611#
5/16		10612#
3/8		10613#
1/2		10614#
1/2 Long		10614L
7/16		1060-716

8

10		10615#
10 Slim		10615E#
1/4		10616#
1/4 Slim		10616E#
5/16		10617#
5/16 Slim .345		10617E
3/8		10618#
1/2		10619
7/16		1061-716

6

10 Slim		10898
1/4		10620#
1/4 Slim		10899
5/16		10621#
3/8		10622#
1/2		10623#
7/16		1062-716

4

10		10635
1/4		10628
5/16		10629
3/8		10630
1/2		10631

2

1/4 Ring		10634#
3/8 Ring		10632#
1/2 Ring		10633#

1/0

3/8 Ring		10636
----------	--	-------

2/0

3/8 Ring		10646
----------	--	-------

3/0

Ring Tongue

Vinyl Insulated

Wire Size	Stud Size	Part No.
24-20	4	22404#
	6	22406#
	8	22408#
	10	22410#
22-18	4	50014
	6	50020*
	6 .187 Barrel	50020E
	6 Slim	50021
	6 Slim .187 Barrel	50021E
	8	50030*
	8 Slim	50038
	8 Slim .187 Barrel	50038E
	10	50040*
	10 .187 Barrel	50040E
	1/4	50041*
	1/4 Slim	50044*
	1/4 Slim .187 Barrel	50044E
	5/16	50042*
	5/16 .187 Barrel	50042E
	3/8	50043*
1/2	50204	
16-14	4	50084
	6 Slim	50085
	6	50086*
	6 .187 Barrel	50086E
	8	50090*
	8 Slim	50098
	8 Slim .187 Barrel	50098E
	10	50100*
	10 .187 Barrel	50100E
	1/4	50101*
	1/4 Slim	50114*
	1/4 Slim .187 Barrel	50114E
	5/16	50102*
	5/16 .187 Barrel	50102E
5/16 Wide .558	50106	
3/8	50103*	
1/2	50104*	
12-10	4	50205
	6	50210*
	6 Slim	50215
	8	50220*
	8 Slim	50225
	10	50230*
	1/4	50240*
	1/4 Slim	50245*
	5/16	50250*
	3/8	50260*
1/2	50233*	
1/2 Wide	50235	
8	8	50608
	10 Slim	50609
	10	50610
	1/4	50611
	5/16	50612
	3/8	50613
	1/2	50614
	1/2 Long	50614L
5/8	2060-58	
7/16	5060-716	
6	10	50615
	10 Slim	50615E
	1/4	50616
	1/4 Slim	50616E
	5/16	50617
	5/16 Slim .345	50617E
	3/8	50618
	1/2	50619
7/16	5061-716	
4	1/4	20620
	1/2	20623

Nylon Insulated

Wire Size	Stud Size	Part No.
24-20	4	22404N
	6	22406N
	8	22408N
	10	22410N
22-18	4	50014N
	6	50020N*
	6 .187 Barrel	50020EN
	6 Slim	50021N
	6 Slim .187 Barrel	50021EN
	8	50030N*
	8 Slim	50038N
	8 Slim .187 Barrel	50038EN
	10	50040N*
	10 .187 Barrel	50040EN
	1/4	50041N*
	1/4 Slim	50044N*
	1/4 Slim .187 Barrel	50044EN
	5/16	50042N*
	5/16 .187 Barrel	50042EN
	3/8	50043N*
1/2	50204N	
16-14	4	50084N
	6 Slim	50085N
	6	50086N*
	6 .187 Barrel	50086EN
	8	50090N*
	8 Slim	50098N
	8 Slim .187 Barrel	50098EN
	10	50100N*
	10 .187 Barrel	50100EN
	1/4	50101N*
	1/4 Slim	50114N*
	1/4 Slim .187 Barrel	50114EN
	5/16	50102N*
	5/16 .187 Barrel	50102EN
5/16 Wide .558	50106N	
3/8	50103N*	
1/2	50104N	
12-10	4	50205N
	6	50210N*
	6 Slim	50215N
	8	50220N*
	8 Slim	50225N
	10	50230N*
	1/4	50240N*
	1/4 Slim	50245N*
	5/16	50250N*
	3/8	50260N*
1/2	50233N*	
8	8	50608N
	10 Slim	50609N
	10	50610N
	1/4	50611N
	5/16	50612N
	3/8	50613N
	1/2	50614N
	1/2 Long	50614LN
5/8	5060-716N	
6	10	50615N
	10 Slim	50615EN
	1/4	50616N
	1/4 Slim	50616EN
	5/16	50617N
	5/16 Slim .345	50617EN
	3/8	50618N
	1/2	50619N
7/16	5061-716N	
4	10 Slim	50898N
	1/4	50620N
	1/4 Slim	50899N
	5/16	50621N
	3/8	50622N
	1/2	50623N
7/16	5062-716N	
2	1/4	50628N
	5/16	50629N
	3/8	50630N
2/0	1/2	50631N
	3/8	50636N



Get quote >>

Angic Global Solutions

1-888-872-0690

<https://www.AngicGlobal.com> Sales@AngicGlobal.com

Ring Tongue

3-Pc Nylon w/ Sleeve

Wire Size	Stud Size	Part No.
24-20	4	32404
	6	32406
	8	32408
	10	32410
22-18	4	30014
	6	30020
	6 Slim	30021
	8	30030
	8 Slim	30038
	10	30040
	1/4	30041
	1/4 Slim	30044
	5/16	30042
	3/8	30043
	1/2	30204
16-14	4	30084
	6	30086
	6 Slim	30085
	8	30090
	8 Slim	30098
	10	30100
	1/4	30101
	1/4 Slim	30114
	5/16	30102
	3/8	30103
	1/2	30104
12-10	4	30205
	6	30210
	6 Slim	30215
	8	30220
	8 Slim	30225
	10	30230
	1/4	30240
	1/4 Slim	30245
	5/16	30250
	3/8	30260
	1/2	30233
3 PC TOOL		20717



Heat Shrink

Wire Size	Stud Size	Polyolefin Part No.	NYAX Part No.
22-18	4	40014	70014
	6	40020	70020
	6 Slim	40021	70021
	8	40030	70030
	8 Long Neck	40030L	70030L
	8 Slim	40038	70038
	10	40040	70040
	10 Long Neck	40040L	70040L
	1/4	40041	70041
	1/4 Slim	40044	70044
	5/16	40042	70042
3/8	40043	70043	
1/2	40204	70204	
16-14	4	40084	70084
	6	40086	70086
	6 Slim	40085	70085
	8	40090	70090
	8 Long Neck	40090L	70090L
	8 Slim	40098	70098
	10	40100	70100
	10 Long Neck	40100L	70100L
	1/4	40101	70101
	1/4 Slim	40114	70114
	5/16	40102	70102
3/8	40103	70103	
1/2	40104	70104	
12-10	4	40205	70205
	6	40210	70210
	6 Slim	40215	70215
	8	40220	70220
	8 Slim	40225	70225
	10	40230	70230
	10 Long Neck	40230L	70230L
	10 Wide	40236	70236
	1/4	40240	70240
	1/4 Slim	40245	70245
	5/16	40250	70250
3/8	40260	70260	
1/2	40233	70233	
8	8	40608	70608
	10 Slim	40609	70609
	10	40610	70610
	1/4	40611	70611
	5/16	40612	70612
	3/8	40613	70613
	1/2	40614	70614
1/2 Long Neck	40614L	70614L	



Ring Tongues & Closed End Connectors

Closed End Connectors

Copper Insert

Wire Size	Part No.
22-18	20569#
16-14 Flat top	20570#
	20575#
12-10	20571#
8	20572#

Aluminum Insert

Wire Size	Part No.
22-18	20569A#
16-14	20570A#
12-10	20571A#
8	20572A#



See Page 37 for corresponding Tool (20709)

Item #	Description	Dimensions			
10571B#	22-18 Brass Crimp Cap	L=.374	D=.295	C=.205	W=.24
10571C#	22-18 Copper Crimp Cap	L=.374	D=.295	C=.205	W=.24
10572B#	14-08 Brass Crimp Cap	L=.61	D=.366	C=.264	W=.307
10572C#	14-08 Copper Crimp Cap	L=.61	D=.366	C=.264	W=.307



Multi Stud Ring Tongue

Bare Butted Seam

Wire Size	Stud Size	Part No.
22-18	6-8-10	10040M*
16-14	6-8-10	10100M*
12-10	6-8-10	10230M*



Nylon Insulated

Wire Size	Stud Size	Part No.
22-18	6-8-10	50040MN*
16-14	6-8-10	50100MN*
12-10	6-8-10	50230MN*



Bare Brazed Seam

Wire Size	Stud Size	Part No.
22-18	6-8-10	10040MBZ*
16-14	6-8-10	10100MBZ*
12-10	6-8-10	10230MBZ*



3-Pc Nylon w/ Sleeve

Wire Size	Stud Size	Part No.
22-18	6-8-10	30040M
16-14	6-8-10	30100M
12-10	6-8-10	30230M



Vinyl Insulated

Wire Size	Stud Size	Part No.
22-18	6-8-10	50040M*
16-14	6-8-10	50100M*
12-10	6-8-10	50230M*



3 PC TOOL 20717

Heat Shrink

Wire Size	Stud Size	Polyolefin	NYAX
22-18	6-8-10	40040M	70040M
16-14	6-8-10	40100M	70100M
12-10	6-8-10	40230M	70230M



Star Rings

Blades can pierce surfaces to ensure a good connection

Bare Butted

Wire Size	Stud Size	Part No.
22-18	8	10302

Vinyl Insulated

Wire Size	Stud Size	Part No.
22-18	6	50301#
	8	50302#
16-14	8	50305#
	10	50306#
12-10	10	50308#



WIRE SIZE CROSS REFERENCE

Metric mm ²	AWG
0.5	26-22
1.25	22-16
2.0	16-14
5.5	12-10
8.0	8
14.0	6
22.0	4
35.0	2
60.0	1/0
70.0	2/0
80.0	3/0
100.0	4/0

Bare Butted Seam

Wire Size	Stud Size	Part No.
22-18	4	10054
	6	10050*
	6 Short	10055
	8	10060*
	10	10070*
	1/4	10075
16-14	6	10140*
	6 Wide	10147
	8	10150*
	10	10160*
	1/4	10165*
12-10	6	10270*
	8	10280*
	10	10290*
	1/4	10234*



Vinyl Insulated

Wire Size	Stud Size	Part No.
24-20	4	22414#
	6	22416#
	8	22418#
	10	22420#
22-18	4	50054
	6	50050*
	6 Short	50055
	8	50060*
	10	50070*
	1/4	50075
16-14	6	50140*
	6 Wide	50147
	8	50150*
	10	50160*
	1/4	50165*
12-10	6	50270*
	8	50280*
	10	50290*
	1/4	50234*
8	10	50607
	1/4	50606



Bare Brazed Seam

24-20	4	12414#
	6	12416#
	8	12418#
	10	12420#
22-18	4	10054BZ
	6	10050BZ*
	6 Short	10055BZ
	8	10060BZ*
	10	10070BZ*
	1/4	10075BZ
16-14	6	10140BZ*
	8	10150BZ*
	10	10160BZ*
	1/4	10165BZ*
12-10	6	10270BZ*
	8	10280BZ*
	10	10290BZ*
	1/4	10234BZ*
8	10	10607
	1/4	10606
6	1/4	10726



Nylon Insulated

24-20	4	22414N
	6	22416N
	8	22418N
	10	22420N
22-18	4	50054N
	6	50050N*
	6 Short	50055N
	8	50060N*
	10	50070N*
	1/4	50075N
16-14	6	50140N*
	6 Wide	50147N
	8	50150N*
	10	50160N*
	1/4	50165N*
12-10	6	50270N*
	8	50280N*
	10	50290N*
	1/4	50234N*
8	10	50607N
	1/4	50606N
6	1/4	20726N#



Stud Size Guide



3-Pc Nylon w/ Sleeve

Wire Size	Stud Size	Part No.
24-20	4	32414
	6	32416
	8	32418
	10	32420
22-18	4	30054
	6	30050
	6 Short	30055
	8	30060
	10	30070
	1/4	30075
16-14	6	30140
	6 Wide	30147
	8	30150
	10	30160
	1/4	30165
12-10	6	30270
	8	30280
	10	30290
	1/4	30234

3 PC. TOOL 20717

Heat Shrink

Wire Size	Stud Size	Polyolefin Part No.	NYAX Part No.
22-18	4	40054	70054
	6	40050	70050
	6 Short	40055	70055
	8	40060	70060
	10	40070	70070
	1/4	40075	70075
16-14	6	40140	70140
	8	40150	70150
	10	40160	70160
	1/4	40165	70165
12-10	6	40270	70270
	8	40280	70280
	10	40290	70290
	1/4	40234	70234

Flanged Spades

Bare Butted Seam

22-18	6	10053
	8	10063
	10	10073
16-14	6	10143
	8	10153
	10	10163
12-10	6	10273
	8	10283
	10	10293

Nylon Insulated

22-18	6	50053N
	8	50063N
	10	50073N
16-14	6	50143N
	8	50153N
	10	50163N
12-10	6	50273N
	8	50283N
	10	50293N

3 Piece Nylon

22-18	6	30053
	8	30063
	10	30073
16-14	6	30143
	8	30153
	10	30163
12-10	6	30273
	8	30283
	10	30293

3 PC. TOOL 20717

Vinyl Insulated

22-18	6	50053
	8	50063
	10	50073
16-14	6	50143
	8	50153
	10	50163
12-10	6	50273
	8	50283
	10	50293

Heat Shrink

Wire Size	Stud Size	Polyolefin Part No.	NYAX Part No.
22-18	6	40053	70053
	8	40063	70063
	10	40073	70073
16-14	6	40143	70143
	8	40153	70153
	10	40163	70163
12-10	6	40273	70273
	8	40283	70283
	10	40293	70293



Get quote »

Angic Global Solutions

1-888-872-0690

<https://www.AngicGlobal.com> Sales@AngicGlobal.com

Bare Butted Seam

Wire Size	Stud Size	Part No.
22-18	6	10052*
	6 Wide	10056
	8	10062*
	8 Slim	10068
	10	10072*



16-14	4	10144
	6	10142*
	6 Wide	10146
	8	10152*
	8 Slim	10158
	10	10162*



12-10	6	10272*
	8	10282*
	10	10292*



Bare Brazed Seam

22-18	6	10052BZ*
	6 Wide	10056BZ
	8	10062BZ*
	8 Slim	10068BZ
	10	10072BZ*



16-14	4	10144BZ
	6	10142BZ*
	6 Wide	10146BZ
	8	10152BZ*
	8 Slim	10158BZ
	10	10162BZ*



12-10	6	10272BZ*
	8	10282BZ*
	10	10292BZ*



Vinyl Insulated

22-18	6	50052*
	6 Wide	50056
	8	50062*
	8 Slim	50068
	10	50072*



16-14	4	50144
	6	50142*
	6 Wide	50146
	8	50152*
	8 Slim	50158
	10	50162*



12-10	6	50272*
	8	50282*
	10	50292*



Nylon Insulated

22-18	6	50052N*
	6 Wide	50056N
	8	50062N*
	8 Slim	50068N
	10	50072N*



16-14	4	50144N
	6	50142N*
	6 Wide	50146N
	8	50152N*
	8 Slim	50158N
	10	50162N*



12-10	6	50272N*
	8	50282N*
	10	50292N*



3-Pc Nylon w/ Sleeve

22-18	6	30052
	6 Wide	30056
	8	30062
	8 Slim	30068
	10	30072



16-14	4	30144
	6	30142
	6 Wide	30146
	8	30152
	8 Slim	30158
	10	30162



12-10	6	30272
	8	30282
	10	30292



3 PC. TOOL 20717

Heat Shrink

Wire Size	Stud Size	Polyolefin Part No.	NYAX Part No.
22-18	6	40052	70052
	6 Wide	40056	70056
	8	40062	70062
	8 slim	40068	70068
	10	40072	70072



16-14	4	40144	70144
	6	40142	70142
	6 Wide	40146	70146
	8	40152	70152
	8 Slim	40158	70158
	10	40162	70162



12-10	6	40272	70272
	8	40282	70282
	10	40292	70292



Bare Butted Seam

Wire Size	Stud Size	Part No.
22-18	6	10051*
	8	10061*
	10	10071*
.....		
16-14	6	10141*
	8	10151*
	10	10161*
	1/4	10231
.....		
12-10	6	10271*
	8	10281*
	10	10291*
	1/4	10241*

Nylon Insulated

Wire Size	Stud Size	Part No.
22-18	6	50051N*
	8	50061N*
	10	50071N*
.....		
16-14	6	50141N*
	8	50151N*
	10	50161N*
	1/4	50231N
.....		
12-10	6	50271N*
	8	50281N*
	10	50291N*
	1/4	50241N*

Bare Brazed Seam

Wire Size	Stud Size	Part No.
22-18	6	10051BZ*
	8	10061BZ*
	10	10071BZ*
.....		
16-14	6	10141BZ*
	8	10151BZ*
	10	10161BZ*
	
12-10	6	10271BZ*
	8	10281BZ*
	10	10291BZ*
	1/4	10241BZ*

3-Pc Nylon w/ Sleeve

Wire Size	Stud Size	Part No.
22-18	6	30051
	8	30061
	10	30071
.....		
16-14	6	30141
	8	30151
	10	30161
	1/4	30231
.....		
12-10	6	30271
	8	30281
	10	30291
	1/4	30241

3 PC. TOOL 20717

Vinyl Insulated

Wire Size	Stud Size	Part No.
22-18	6	50051*
	8	50061*
	10	50071*
.....		
16-14	6	50141*
	8	50151*
	10	50161*
	1/4	50231
.....		
12-10	6	50271*
	8	50281*
	10	50291*
	1/4	50241*

Heat Shrink

Wire Size	Stud Size	Polyolefin Part No.	NYAX Part No.
22-18	6	40051	70051
	8	40061	70061
	10	40071	70071
.....			
16-14	6	40141	70141
	8	40151	70151
	10	40161	70161
.....			
12-10	6	40271	70271
	8	40281	70281
	10	40291	70291
	1/4	40241	70241



Get quote >>

Bare Butted Seam

Wire Size	Stud Size	Part No.
22-18	6	10067
	8	10077
	10	10087



16-14	6	10105*
	8	10110*
	10	10120*



12-10	6	10128
	8	10129
	10	10130*



Bare Brazed Seam

22-18	6	10067BZ
	8	10077BZ
	10	10087BZ



16-14	6	10105BZ*
	8	10110BZ*
	10	10120BZ*



12-10	10	10130BZ*
-------	----	----------



Nylon Insulated

Wire Size	Stud Size	Part No.
22-18	6	50067N
	8	50077N
	10	50087N



16-14	6	50105N*
	8	50110N*
	10	50120N*



12-10	6	50128N
	8	50129N
	10	50130N*



3-Pc Nylon w/ Sleeve

22-18	6	30067
	8	30077
	10	30087



16-14	6	30105
	8	30110
	10	30120



12-10	6	30128
	8	30129
	10	30130



3 PC. TOOL 20717

Vinyl Insulated

22-18	6	50067
	8	50077
	10	50087



16-14	6	50105*
	8	50110*
	10	50120*



12-10	6	50128
	8	50129
	10	50130*



Heat Shrink

Wire Size	Stud Size	Polyolefin Part No.	NYAX Part No.
22-18	6	40067	70067
	8	40077	70077
	10	40087	70087



16-14	6	40105	70105
	8	40110	70110
	10	40120	70120









12-10	6	40128	70128
	8	40129	70129
	10	40130	70130



The brazed seam will not separate under pressure of operating stress.
 A funnel entry nylon insulator allows easy wire insertion.

Rings

Wire Size	Stud Size	Part No.	
22-18	6	50020BZN+	
	8	50030BZN+	
	10	50040BZN+	
	6-8-10	50040MBZN	
	1/4	50041BZN+	
16-14	5/16	50042BZN+	
	3/8	50043BZN+	
	6	50086BZN+	
	8	50090BZN+	
	10	50100BZN+	
12-10	6-8-10	50100MBZN	
	1/4	50101BZN+	
	5/16	50102BZN+	
	3/8	50103BZN+	
	1/2	50104BZN+	
12-10	6	50210BZN+	
	8	50220BZN+	
	10	50230BZN+	
	6-8-10	50230MBZN	
	1/4	50240BZN+	
12-10	5/16	50250BZN+	
	3/8	50260BZN+	
	1/2	50233BZN+	





Multi Stud Ring

22-18	6-8-10	50040MBZN	
16-14	6-8-10	50100MBZN	
12-10	6-8-10	50230MBZN	



Male Quick Disconnects

22-18	.250 x .032	50177BZN	
16-14	.250 x .032	50181BZN	
12-10	.250 x .032	50186BZN	

Spades

Wire Size	Stud Size	Part No.	
22-18	6	50050BZN+	
	8	50060BZN+	
	10	50070BZN+	
16-14	6	50140BZN+	
	8	50150BZN+	
	10	50160BZN+	
12-10	6	50270BZN+	
	8	50280BZN+	
	10	50290BZN+	

Snap Spades

22-18	6	50051BZN+	
22-18	8	50061BZN+	
	10	50071BZN+	
16-14	6	50141BZN+	
	8	50151BZN+	
	10	50161BZN+	
12-10	6	50271BZN+	
	8	50281BZN+	
	10	50291BZN+	
	1/4	50241BZN+	

Block Spades







22-18	6	50052BZN+	
	8	50062BZN+	
	10	50072BZN+	
16-14	6	50142BZN+	
	8	50152BZN+	
	10	50162BZN+	
12-10	6	50272BZN+	
	8	50282BZN+	
	10	50292BZN+	

Nylon Insulated Brazed Barrel



Non-Insulated Butted Seam Terminals are made of steel. They are nickel plated for temperatures up to 900° F (482° C)





Rings

Wire Size	Tab Width	Steel Nickel Plated	
22-18	6 Slim	10021HT	
	6	10020HT	
	8	10030HT	
	8	10038HT	
	10	10040HT	
	1/4	10041HT	
	5/16	10042HT	
3/8	10043HT		
16-14	6 Slim	10085HT	
	6	10086HT	
	8	10090HT	
	10	10100HT	
	1/4 Slim	10114HT	
	1/4	10101HT	
	5/16	10102HT	
	3/8	10103HT	
12-10	6	10210HT	
	8	10220HT	
	10	10230HT	
	1/4 Slim	10245HT	
	1/4	10240HT	
	5/16	10250HT	
	3/8	10260HT	
1/2	10233HT		
8	10	10610HT	
	1/4	10611HT	
	5/16	10612HT	
	3/8	10613HT	
6	10	10615HT	
	1/4	10616HT	
	5/16	10617HT	
	3/8	10618HT	
4	5/16	10621HT	
	3/8	10622HT	
2	1/4	10628HT	
	5/16	10629HT	
	3/8	10630HT	



Butt Connectors

22-18	10080HT	
16-14	10170HT	
12-10	10310HT	

Quick Connects

Wire Size	Tab Width	Steel Nickel Plated	
22-18	.250 x .032 Female	10176HT	
	.250 x .032 Male	10177HT	
	.187 x .020 Female	10192HT	
16-14	.187 x .020 Female	10195HT	
	.250 x .032 Female	10180HT	
	.250 x .032 Male	10181HT	
12-10	.250 x .032 Female	10187HT	
	.250 x .032 Male	10186HT	

Spades

22-18	6	10050HT	
	8	10060HT	
	10	10070HT	
16-14	6	10140HT	
	8	10150HT	
	10	10160HT	
12-10	6	10270HT	
	8	10280HT	
	10	10290HT	
	1/4	10234HT	

Block Spade

16-14	8	10152HT	
12-10	10	10292HT	

Flags

16-14	.250 Female	10189HT	
-------	-------------	---------	---



Bare Seamless

Wire Size	Stud Size	Copper Nickel Plated
22-18		10083LNP
16-14		10173XLNP
12-10		10313LNP



Bare Brazed Rings

Wire Size	Stud Size	Copper Nickel Plated
16-14	10	10100BZNP
12-10	8	10220BZNP
12-10	10	10230BZNP
12-10	1/4	10240BZNP



Bare Butted

22-18	10080NP
16-14	10170NP
12-10	10310NP



Non-Insulated butted, seamless and brazed seam parts are made of copper. They are nickel plated for temperatures up to 650° F (343° C).

Piggyback Connectors

Bare Butted Seam

Wire Size	Tab Width	Part No.
22-18	.250 x .032	10662
16-14	.250 x .032	10663
12-10	.250 x .032	10666



Vinyl Insulated

22-18	.250 x .032	20662#
16-14	.250 x .032	20663#
12-10	.250 x .032	20664#



Nylon Insulated

22-18	.250 x .032	20662N#
16-14	.250 x .032	20663N#
12-10	.250 x .032	20664N#



3-Pc Nylon w/ Sleeve

Wire Size	Tab Width	Part No.
22-18	.250 x .032	30662#
16-14	.250 x .032	30663#
12-10	.250 x .032	30664#



3-Pc Nylon Fully Insulated

22-18	.250 x .032	32662#
16-14	.250 x .032	32663#
3 PC. TOOL		20717



Heat Shrink

Wire Size	Stud Size	Polyolefin Part No.	NYAX
22-18	.250 x .032	40662	70662
16-14	.250 x .032	40663	70663
12-10	.250 x .032	40664	70664



Piggyback & High Temp



Get quote >>

Bare Butted Seam

Wire Size	Tab Width	Part No.
22-18	.110 x .020	10191#
	.187 x .020	10192
	.205 x .020	10193
	.250 x .032	10176

16-14	.110 x .020	10194#
	.187 x .020	10195
	.205 x .020	10196
	.250 x .032	10180

12-10	.250 x .032	10187
	.375 x .032	10166



3-Pc Nylon w/ Sleeve

Wire Size	Tab Width	Part No.
22-18	.110 x .020	30191#
	.187 x .020	30192#
	.250 x .032	30176#

16-14	.110 x .020	30194#
	.187 x .020	30195
	.250 x .032	30180
	.375 x .032	30375

12-10	.187 x .032	30167
	.250 x .032	30187#
	.375 x .032	30166
Larger Barrel	.250 x .032	30187B



3 PC. TOOL 20717

Vinyl Insulated

22-18	.110 x .020	20191#
	.187 x .020	20192#
	.187 x .020	50192
	.205 x .020	20193#
	.205 x .020	50193
	.250 x .032	50176

16-14	.110 x .020	20194#
	.187 x .020	20195#
	.187 x .020	50195
	.205 x .020	20196#
	.205 x .020	50196
	.250 x .032	50180
	.375 x .032	20375
	.205 x .032	20493#

12-10	.187 x .032	20167
	.250 x .032	50187
	.375 x .032	20166
Larger Barrel	.250 X .032	50187B



Heat Shrink

Wire Size	Stud Size	Polyolefin Part No.	NYAX Part No.
22-18	.110 x .020	40191	70191
	.187 x .020	40192	70192
	.250 x .032	40176	70176

16-14	.110 x .020	40194	70194
	.187 x .020	40195	70195
	.250 x .032	40180	70180
	.250 x .032	40180BRS (Brass Sleeve)	

12-10	.250 x .032	40187	70187
	.250 x .032	40187B	70187B (Large ID)
	.250 x .032	40187BRS (Brass Sleeve)	
	.375 x .032	40166	70166



Nylon Insulated

22-18	.110 x .032	20491N#
	.187 x .020	50192N
	.205 x .020	50193N
	.250 x .032	50176N

16-14	.187 x .020	20195N#
	.187 x .020	50195N
	.205 x .020	50196N
	.250 x .032	50180N
	.375 x .032	20375N

12-10	.187 x .032	20167N
	.250 x .032	50187N Rolled
	.375 x .032	20166N
	.250 x .032	50213N Folded



The part No.s beginning in "2"
are Extruded Vinyl.

The parts No.s beginning in "5"
are Injection Molded with funnel entry.

Bare Butted Seam

Wire Size	Tab Width	Part No.
22-18	.110 x .020	10088#
	.187 x .020	10197
	.250 x .032	10177*



16-14	.110 x .020	10089
	.187 x .020	10198
	.250 x .032	10181



12-10	.250 x .032	10186*
-------	-------------	--------



Bare Brazed Seam

22-18	.250 x .032	10177BZ
	.187 x .020	10197BZ



16-14	.250 x .032	10181BZ
	.187 x .020	10198BZ



12-10	.250 x .032	10186BZ
-------	-------------	---------



Vinyl Insulated

22-18	.110 x .020	20088#
	.187 x .020	50197
	.250 x .032	50177*
	.187 x .020	20197#



16-14	.110 x .020	20089
	.187 x .020	50198
	.250 x .032	50181



12-10	.250 x .032	50186*
-------	-------------	--------



Nylon Insulated

Wire Size	Tab Width	Part No.
22-18	.250 x .032	50177N*
	.187 x .020	50197N



16-14	.187 x .020	50198N
	.187 x .020	20198N
	.250 x .032	50181N*



12-10	.250 x .032	50186N*
-------	-------------	---------



3-Pc Nylon w/ Sleeve

22-18	.187 x .020	30197#
	.250 x .032	30177



16-14	.187 x .020	30198#
	.250 x .032	30181



12-10	.250 x .032	30186
-------	-------------	-------



3 PC. TOOL 20717

Heat Shrink

Wire Size	Stud Size	Polyolefin Part No.	NYAX Part No.
22-18	.110 x .020	40088	70088
	.187 x .020	40197	70197
	.250 x .032	40177	70177



16-14	.110 x .020	40089	70089
	.187 x .020	40198	70198
	.250 x .032	40181	70181



12-10	.250 x .032	40186	70186
-------	-------------	-------	-------



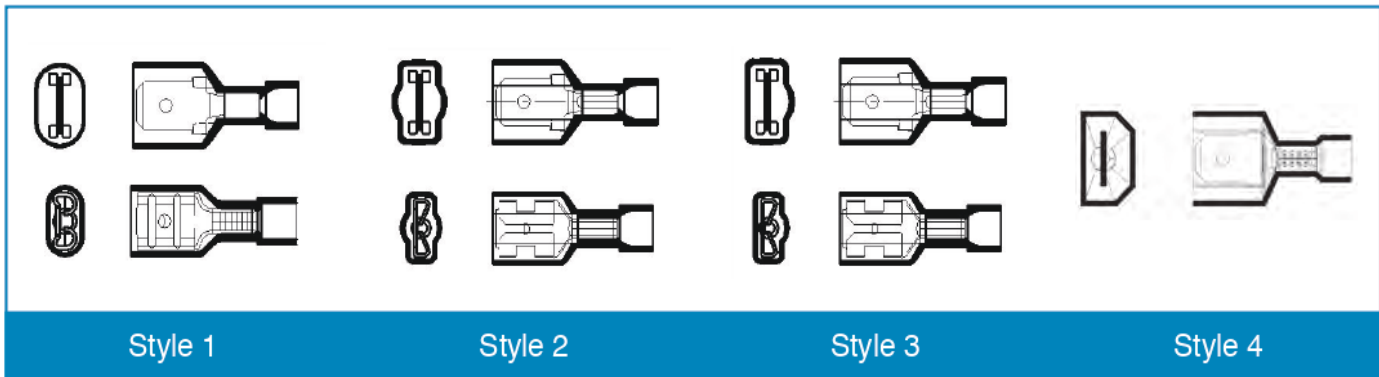

Nylon			
Wire Size	Style	Tab Width	Part No.
22-18	1	.250 X .032 Male	20178#
	1	.250 X .032 Female	20179#
	1	.250 X .032 Female	50179
	2	.250 X .032 Male	50206
	2	.250 X .032 Female	50207
	3	.250 X .032 Male	50206-1 Hump
	3	.250 X .032 Female	50207-1 Hump
	4	.250 X .032 Male	50206A Flat Side#
	4	.110 X .020 Female	22191N#
	4	.187 X .020 Female	22192N#
	4	.187 X .020 Male	22197N
	4	.205 X .020 Female	22193N
.....			
16-14	1	.250 X .032 Male	20182#
	1	.250 X .032 Female	20183#
	1	.250 X .032 Female	50183
	2	.250 X .032 Male	50208
	2	.250 X .032 Female	50209
	3	.250 X .032 Male	50208-1 Hump
	3	.250 X .032 Female	50209-1 Hump
	4	.250 X .032 Male	50208A Flat Side#
	4	.110 X .020 Female	22194N#
	4	.187 X .020 Female	22195N
	4	.187 X .020 Male	22198N
		
12-10	2	.250 X .032 Male	50212
	2	.250 X .032 Female	50213
	3	.250 X .032 Female	50213-1 Hump
	3	.250 X .032 Female	50213L
	3	.250 X .032 Male	50212L

3-Pc Fully Nylon w/Sleeve			
Wire Size	Style	Tab Width	Part No.
22-18	1	.110 X .020 Female	32191#
	3	.187 X .020 Male	32197#
	3	.187 X .020 Female	32192#
	3	.187 X .032	33192#
	1	.250 X .032 Male	30178#
	1	.250 X .032 Female	30179#
.....			
16-14	3	.187 X .020 Male	32198#
	3	.187 X .020 Female	32195#
	3	.187 X .032 Female	33195#
	1	.250 X .032 Male	30182#
	1	.250 X .032 Female	30183#
		
12-10	3	.250 X .032 Female	30199
	1	.250 X .032 Male	30212#
	1	.250 X .032 Female	30213#
.....			
		3 PC. TOOL	20717

Fully Insulated Vinyl			
Wire Size	Style	Tab Width	Part No.
16-14	1	.187 X .020 Female	52195#

Heat Shrink					
Wire Size	Style	Tab Width	Polyolefin Part No.	NYAX Part No.	
22-18	1	.110 X .020 Female	42191		
	1	.250 X .032 Male	44178	74178	
	1	.250 X .032 Female	44179	74179	
	2	.250 X .032 Male	40206	70206	
	2	.250 X .032 Female	40207	70207	
	3	.187 X .020 Female	42192		
	3	.187 X .020 Male	42197		
	3	.250 X .032 Female	40207-1Hump	70207-1Hump	
	3	.250 X .032 Male	40206-1Hump	70206-1Hump	
				
	16-14	1	.250 X .032 Male	44182	74182
		1	.250 X .032 Female	44183	74183
2		.250 X .032 Male	40208	70208	
2		.250 X .032 Female	40209	70209	
3		.187 X .020 Female	42195		
3		.187 X .020 Male	42198		
3		.250 X .032 Female	40209-1Hump	70209-1Hump	
3		.250 X .032 Male	40208-1Hump	70208-1Hump	
.....					
12-10	2	.250 X .032 Male	40212	70212	
	2	.250 X .032 Female	40213	70213	
	2	.250 X .032 Female	30213-HS		

NEW Style: Tubing has been shortened to expose the improved crimping area.



Heat Shrink (NEW STYLE)				
Wire Size	Style	Tab Width	Polyolefin Part No.	NYAX Part No.
22-18	2	.250 X .032 MALE	90206	
	2	.250 X .032 FEM	90207	
	3	.187 X .020 FEM	92192	
.....				
16-14	2	.250 X .032 MALE	90208	
	2	.250 X .032 FEM	90209	
.....				
12-10		.250 X .032 FEM	90213	
		.250 X .032 MALE	99212	
		.250 X .032 FEM	90213-1 Hump	

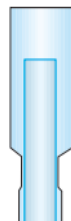

Bare Butted Seam

Wire Size	Tab Width	Part No.
22-18	.157 Male	10284
	.157 Female	10285
16-14	.157 Male	10184
	.157 Female	10185
	.195 Male	10484
	.180 Male	10684
12-10	.195 Male	10384

3-Pc Nylon w/ Sleeve

Wire Size	Tab Width	Part No.
22-18	.157 Male	30884 Fully [^]
	.157 Male	30284
	.157 Female	30285R [^]
16-14	.157 Male	30984 Fully [^]
	.157 Male	30184 [^]
	.157 Female	30185 [^]
3 PC. TOOL		20717

Vinyl Insulated

22-18	.157 Male	20284V [^]
	.157 Female	20285V [^]
	.180 Male	20784V [^]
	.180 Female	20785V
16-14	.157 Male	20184V [^]
	.157 Female	20185V [^]
	.180 Male	20684V [^]
	.180 Female	20685V
	.195 Male	20484V [^]
12-10	.195 Male	20384V [^]
	.195 Female	20385V [^]

Nylon Insulated

22-18	.157 Male	20884 Fully [^]
	.157 Male	20284 [^]
	.157 Female	20285 [^]
	.180 Male	20784 [^]
	.180 Female	20785 [^]
16-14	.157 Male	20984 Fully [^]
	.157 Male	20184 [^]
	.157 Female	20185 [^]
	.180 Male	20684 [^]
	.180 Female	20685 [^]
12-10	.195 Male	20485 Fully [^]
	.195 Female	20485 Fully [^]

Heat Shrink

Wire Size	Polyolefin Part No.	NYAX Part No.	
22-18	.157 N/I Fem Bullet	40285	70285N
	.157 V/I Fem Bullet		70285
	.157 3pc N/I Female	93285	
	.157 N/I Female	90285	
	.157 U/I Male Bullet	40284	70284
	.157 N/I Male Bullet		70284N
	.157 3pc N/I Male	93284	
	.157 N/I Male Bullet	90284	
	.180 V/I Fem Bullet	40785	70785
	.180 N/I Fem Bullet		70785N
	.180 N/I Fem Bullet	90785N	
	.180 V/I Male Bullet	40784	70784
	.157 N/I Male Bullet		70784N
	.157 N/I Fem Bullet	40185	70185N
	.157 V/I Fem Bullet		70185
	.157 N/I Fem Bullet	90185	
	.157 U/I Male Bullet	40184	70184
	.157 N/I Male Bullet		70184N
16-14	.157 U/I Male Bullet	90184	
	.180 V/I Fem Bullet	40685	70685
	.180 V/I Fem Bullet	90685	
	.180 N/I Fem Bullet	40685N	70685N
	.180 V/I Male Bullet	40684	70684
	.180 V/I Male Bullet	90684	
	.180 N/I Male Bullet	90684N	
	.180 U/I Male Bullet	47684	77684
	.180 N/I Male Bullet		70684N
	.195 V/I Fem Bullet	40485	70485
12-10	.195 N/I Fem Bullet		70485N
	.195 U/I Male Bullet	40484	70484
	.195 V/I Fem Bullet	40385	70385
.195 U/I Male Bullet	40384	70384	

9 SERIES HAS AN EXPANDED CRIMP AREA

WATERPROOF BULLETS & RECEPTACLES

Item #	No Heat Required
WP20184PC	14 GA .157 Male Bullet
WP20185PC	14 GA .157 Female Recp.
WP20284PC	18-16 .157 Male Bullet
WP20285PC	18-16 .157 Female Recp.

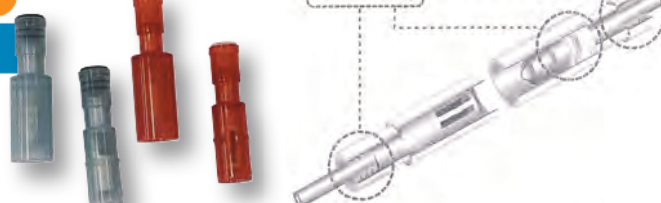

Get quote >>

Bare Butted Seam

Wire Size	Part No.
22-18	10400
16-14	10410
12-10	10420

Brazed Seam

22-18	10400BZ
16-14	10410BZ
12-10	10420BZ

Vinyl

22-18	50400
16-14	50410
12-10	50420



Part No. 50460

Custom 3 and 4 way connectors can be made in any combination of 22-18, 16-14, 12-10 and 8 gauge terminals in bare, brazed, vinyl, nylon, 3 pc or heat shrink.

Nylon

Wire Size	Part No.
22-18	50400N
16-14	50410N
12-10	50420N

3-Pc Nylon w/ Sleeve

22-18	30400
16-14	30410
12-10	30420

Heat Shrink

Wire Size	Polyolefin Part No.	NYAX Part No.
22-18	40430	70430
16-14	40440	70440
12-10	40450	70450

4 Way Connectors

Bare Butted Seam

22-18	10430
16-14	10440
12-10	10450

Brazed Seam

22-18	10430BZ
16-14	10440BZ
12-10	10450BZ

Vinyl

22-18	50430
16-14	50440
12-10	50450



Nylon

22-18	50430N
16-14	50440N
12-10	50450N



3-Pc Nylon w/ Sleeve

22-18	30430
16-14	30440
12-10	30450

Heat Shrink

Wire Size	Polyolefin Part No.	NYAX Part No.
22-18	40430	70430
16-14	40440	70440
12-10	40450	70450



Uninsulated Butted Seam

Wire Size	Part No.	
22-18	UPT1#	
16-14	UPT2#	
12-10	UPT5#	
8	UPT8BZ Brazed#	
4	UPT25-15#	

Vinyl Insulated

Wire Size	Part No.	
22-18	PTV1# PTV1UL*	
16-14	PTV2# PTV2UL*	
12-10	PTV5# PTV5UL*	

2-Pc Nylon

Wire Size	Part No.	
22-18	PTN1#	
16-14	PTN2#	
12-10	PTN5#	
4	PTN25BZ#	



3-Pc Nylon w/ Sleeve

Wire Size	Part No.	
22-18	PT3N1#	
16-14	PT3N2#	
12-10	PT3N5#	

3 PC. TOOL 20717

Flags



Non Insulated

Wire Size	Part No.	Length	Tab Width	
22-18	12188#		.187	
	10188#		.250	
	10999	open	.250	
16-14	12189#		.187	
	10189#		.250#	
	10669		.250 (male)	
12-10	10190#		.250	
	10190B	open	.250	

Heat Shrink

Wire Size	Polyolefin Part No.	NYAX Part No.	Tab Width
22-18	42188	70188	.187
	40188		.250
16-14	42189	70189	.187
	40189		.250
12-10	40190	70190	.250

Nylon Insulated

Wire Size	Part No.	Length	Tab Width	
22-18	22188#	.53	.187	
	20188#	.58	.250	
	20188L#	.82	.250	
16-14	22189#	.53	.187	
	20189#	.58	.250	
	20189L#	.82	.250	
12-10	20190#	.68	.250	
	20190L#	.90	.250	

See Page 39 Tool (20594) for 22-18 and 16-14 and Tool (20704) for 16-14 and 12-10.

VOLTAGE RATINGS

Insulated Copper Terminals	600 volts MAX
Insulated Brass Disconnects	300 volts MAX
Tap Splices (16-10AWG)	32 volts MAX
Tap Splices (18AWG)	18 volts MAX

Heat Shrink Terminals

DESCRIP	WIRE SIZE	STUD/TAB SIZE	CRIMP & SEAL (A)	SOLDER & SEAL (B)	CRIMP, SOLDER & SEAL (C) (C)	NYAX CRIMP & SEAL (A)	CLEAR VIEW CRIMP & SEAL (D)
	24-20 GA	SEAMLESS	40024	60024	80024		
BUTTS	22-18 GA	S/L WINDOW					99082
		SEAMLESS	20082	60082	80082	40082	
		S/L LONG	20082L			40082L	
	16-14 GA	S/L WINDOW					99172
		SEAMLESS	20172	60172	80172	40172	
		S/L LONG	20172L			40172L	
	12-10 GA	S/L WINDOW					99312
		SEAMLESS	20312	60312	80312	40312	
		S/L LONG				40312L	
	8 GA	SEAMLESS	40624	60624		70624	
	6 GA	SEAMLESS	40625				
	STEP DOWN BUTTS	26-24 TO 22-16 GA	SEAMLESS	40315		80315	70315
26-24 TO 22-16 GA		S/L WINDOW					78315
22-18 TO 16-14 GA		SEAMLESS	40316		80316	70316	
22-18 TO 16-14 GA		S/L WINDOW					78316
16-14 TO 12-10 GA		SEAMLESS	40317		80317	70317	
		S/L WINDOW					78317
12-10 TO 8 GA		SEAMLESS	40318		80318	70318	
WINDOW BUTTS	22-18 GA	S/L WINDOW				71082	
	16-14 GA	S/L WINDOW				71172	
	12-10 GA	S/L WINDOW				71312	
RINGS	22-18 GA	4	40014			70014	
		6	40020	60020	80020	70020	
		6 SLIM	40021			70021	
		8	40030	60030	80030	70030	
		8 LONG	40030L			70030L	
		8 SLIM	40038			70038	
		10	40040	60040	80040	70040	
		10 LONG	40040L			70040L	
		1/4	40041	60041	80041	70041	
		1/4 SLIM	40044			70044	
		5/16	40042	60042	80042	70042	
		3/8	40043	60043	80043	70043	
		6-8-10 MULTI	40040M			70040M	
		1/2	40204			70204	
		RINGS	16-14 GA	4	40084		
6	40086					70086	
6 SLIM	40085					70085	
8	40090			60090	80090	70090	
8 LONG	40090L					70090L	
8 SLIM	40098					70098	
10	40100			60100	80100	70100	
10 LONG	40100L					70100L	
1/4	40101			60101	80101	70101	
1/4 SLIM	40114					70114	
5/16	40102			60102	80102	70102	
3/8	40103			60103	80103	70103	
1/2	40104					70104	
6-8-10 MULTI	40100M					70100M	
RINGS	12-10 GA			4	40205		
		6	40210			70210	
		6 SLIM	40215			70215	
		8	40220			70220	
		8 SLIM	40225			70225	
		10	40230	60230	80230	70230	
		10 LONG	40230L			70230L	
		10 WIDE	40236			70236	
		1/4	40240	60240	80240	70240	
		1/4 SLIM	40245			70245	
		5/16	40250	60250	80250	70250	
		3/8	40260	60260	80260	70260	
		1/2	40233	60233	80233	70233	
		6-8-10 MULTI	40230M			70230M	



Heat Shrink Terminals

DESCRIP	WIRE SIZE	STUD/TAB SIZE	CRIMP & SEAL	SOLDER & SEAL	CRIMP, SOLDER & SEAL (C)	NYAX CRIMP & SEAL	CLEAR VIEW CRIMP & SEAL
			(A)	(B)	(C)	(A)	(D)
RINGS	8 GA	8	40608			70608	
		10 SLIM	40609			70609	
		10	40610			70610	
		1/4	40611			70611	
		5/16	40612			70612	
		3/8	40613			70613	
		1/2	40614			70614	
		1/2 LONG	40614L			70614L	
3 WAY	22-18 GA		40400			70400	
	16-14 GA		40410			70410	
	12-10 GA		40420			70420	
4 WAY	22-18 GA		40430			70430	
	16-14 GA		40440			70440	
	12-10 GA		40450			70450	
SPADES	22-18 GA	4	40054			70054	
		6	40050			70050	
		6 SNAP	40051			70051	
		6 BLOCK	40052			70052	
		6 FLANGED	40053			70053	
		6 SHORT	40055			70055	
		6 WIDE BLOCK	40056			70056	
		8	40060			70060	
		8 SNAP	40061			70061	
		8 BLOCK	40062			70062	
		8 FLANGED	40063			70063	
		8 SLIM BLOCK	40068			70068	
		10	40070	60070	80070	70070	
		10 SNAP	40071			70071	
		10 BLOCK	40072			70072	
		10 FLANGED	40073			70073	
		1/4	40075			70075	
		SPADES	16-14 GA	4 BLOCK	40144		
6	40140					70140	
6 SNAP	40141					70141	
6 BLOCK	40142					70142	
6 FLANGED	40143					70143	
6 WIDE BLOCK	40146					70146	
8	40150					70150	
8 SNAP	40151					70151	
8 BLOCK	40152					70152	
8 FLANGED	40153					70153	
8 SLIM BLOCK	40158					70158	
10	40160			60160	80160	70160	
10 SNAP	40161					70161	
10 BLOCK	40162					70162	
10 FLANGED	40163					70163	
1/4	40165			70165			
SPADES	12-10 GA	6	40270			70270	
		6 SNAP	40271			70271	
		6 BLOCK	40272			70272	
		6 FLANGED	40273			70273	
		8	40280			70280	
		8 SNAP	40281			70281	
		8 BLOCK	40282			70282	
		8 FLANGED	40283			70283	
		10	40290	60290	80290	70290	
		10 SNAP	40291			70291	
		10 BLOCK	40292			70292	
		10 FLANGED	40293			70293	
		1/4	40234			70234	
1/4 SNAP	40241			70241			
HOOKS	22-18 GA	6	40067			70067	
		8	40077			70077	
		10	40087			70087	



Get quote 

Heat Shrink Terminals

DESCRIP	WIRE SIZE	STUD/TAB SIZE	CRIMP & SEAL (A)	SOLDER & SEAL (B)	CRIMP, SOLDER & SEAL (C)	NYAX CRIMP & SEAL (A)	CLEAR VIEW CRIMP & SEAL (D)
HOOKS	16-14 GA	6	40105			70105	
		8	40110			70110	
		10	40120			70120	
HOOKS	12-10 GA	6	40128			70128	
		8	40129			70129	
		10	40130			70130	
FLAGS	22-18	.187 TAB FEM	42188			70188	
		.250 TAB FEM	40188			70188	
	16-14	.187 TAB FEM	42189			70189	
		.250 TAB FEM	40189			70189	
	12-10	.250 TAB FEM	40190			70190	
QUICK CONNECTS	22-18 GA	.110 TAB MALE	40088			70088	
		.110 TAB FEM	40191			70191	
		.187 TAB FEM	40192			70192	
		.187 TAB MALE	40197			70197	
		.250 TAB FEM	40176	60176	80176	70176	
		.250 TAB MALE	40177	60177	80177	70177	
QUICK CONNECTS	16-14 GA	.110 TAB MALE	40089			70089	
		.110 TAB FEM	40194			70194	
		.187 TAB FEM	40195			70195	
		.187 TAB MALE	40198				
		.250 TAB FEM	40180	60180	80180	70180	
		.250 TAB MALE	40181	60181	80181	70181	
QUICK CONNECTS	12-10 GA	.250 TAB FEM	40187			70187	
		.250 TAB MALE	40186			70186	
		.375 TAB FEM	40166			70166	
BULLETS	22-18 GA	.157 N/I FEM BULLET	40285			70285N	
		.157 V/I FEM BULLET				70285	
		.157 U/I MALE BULLET	40284			70284	
		.157 N/I MALE BULLET				70284N	
		.180 V/I FEM BULLET	40785			70785	
		.180 N/I FEM BULLET				70785N	
		.180 V/I MALE BULLET	40784			70784	
		.157 N/I MALE BULLET				70784N	
BULLETS	16-14 GA	.157 N/I FEM BULLET	40185			70185N	
		.157 V/I FEM BULLET				70185	
		.157 U/I MALE BULLET	40184			70184	
		.157 N/I MALE BULLET				70184N	
		.180 V/I FEM BULLET	40685			70685	
		.180 N/I FEM BULLET	40685N			70685N	
		.180 V/I MALE BULLET	40684			70684	
		.180 U/I MALE BULLET	47684			77684	
		.180 N/I MALE BULLET				70684N	
		.195 V/I FEM BULLET	40485			70485	
		.195 N/I FEM BULLET				70485N	
		.195 U/I MALE BULLET	40484			70484	
BULLETS	12-10 GA	.195 V/I FEM BULLET	40385			70385	
		.195 U/I MALE BULLET	40384			70384	
PIGGYBACKS	22-18	.250 TAB FEMALE	40662			70662	
	16-14	.250 TAB FEMALE	40663			70663	
	12-10	.250 TAB FEMALE	40664			70664	
FULLY INS	22-18 GA	.250 TAB FEMALE	40207	60179	80179	70207	
		.250 TAB MALE	40206			70206	
QUICK CONNECTS	22-18 GA	.250 TAB FEMALE	40207-1H			70207-1H	
		.250 TAB MALE	40206-1H			70206-1H	
	16-14 GA	.250 TAB FEMALE	40209	60183	80183	70209	
		.250 TAB MALE	40208			70208	
		.250 TAB FEMALE	40209-1H			70209-1H	
12-10 GA	.250 TAB MALE	40208-1H			70208-1H		
	.250 TAB FEMALE	40213	60199	80199	70213		
	.250 TAB MALE	40212			70212		



DESCRIP	WIRE SIZE	STUD/TAB SIZE	CRIMP & SEAL	SOLDER & SEAL	CRIMP, SOLDER & SEAL (C)	NYAX CRIMP & SEAL	CLEAR VIEW CRIMP & SEAL
			(A)	(B)	(C)	(A)	(D)
	22-18 GA	.250 TAB FEMALE	44179			74179	
		.250 TAB MALE	44178			74178	
		.110 TAB FEMALE	42191				
		.187 TAB FEMALE	42192				
		.187 TAB MALE	42197				
	16-14 GA	.250 TAB FEMALE	44183			74183	
		.250 TAB MALE	44182			74182	
		.187 TAB FEMALE	42195				
		.187 TAB MALE	42198				
EXPANDED CRIMP AREA	22-18 GA	.250 TAB MALE	90206				
		.250 TAB FEMALE	90207				
		.187 TAB FEMALE	92192				
EXPANDED CRIMP AREA	16-14 GA	.250 TAB MALE	90208				
		.250 TAB FEMALE	90209				
EXPANDED CRIMP AREA	12-10 GA	.250 TAB MALE	99212				
		.250 TAB FEMALE	90213				
		.250 TAB FEMALE	90213-1H				
EXPANDED CRIMP AREA	22-18 GA	.157 N/I MALE BULLET	90284				
		.157 N/I FEM BULLET	90285				
		.180 N/I FEM BULLET	90785N				
EXPANDED CRIMP AREA	16-14 GA	.157 N/I FEM BULLET	90185				
		.157 N/I MALE BULLET	90184				
		.180 V/I MALE BULLET	90684				
		.180 N/I MALE BULLET	90684N				
		.180 V/I FEM BULLET	90685				
		.180 N/I FEM BULLET	90685N				
HYDRA LINK	24-22	STEP DOWN					HL40315
	22-18	STEP DOWN					HL40316
	16-14	STEP DOWN					HL40317
	12-10	STEP DOWN					HL40318
	22-14 GA	CLOSED END					HL40570
	18-10 GA	CLOSED END					HL40571

Crimp & Seal (A) (D)



Crimp & Seal (A)

Solder & Seal (B)



Solder & Seal (B)

Crimp, Solder & Seal (C)



Crimp, Solder & Seal (C)

The terminals are copper (.110 alloy). The tubing is a high quality polyolefin or Nyax. Seamless connectors used on butts. Multiple wall heat shrinkable tubing, clearly marked. Rings and spades are brazed seam. Color coded with wire size.

DUAL WALL		ADHESIVE LINED						
SHRINK RATIO	OD X LENGTH	COLOR	PART #					
2.5 TO 1	3/16" X 6"	RED	23280					
2.5 TO 1	1/4" X 6"	BLUE	23281					
2.5 TO 1	5/16" X 6"	YELLOW	23282					
THIN WALL		NO ADHESIVE						
2 TO 1	1/4" X 3"	BLACK	23123					
2 TO 1	3/8" X 3"	BLACK	23125					
2 TO 1	1/2" X 3"	BLACK	23127					
RATIO	OD X LENGTH	BLACK	CLEAR	RED	ORANGE	BLUE	GREEN	WHITE
2 TO 1	3/64" X 100 FT		23364C					
2 TO 1	3/64" X 1320 FT	23617						
2 TO 1	1/16" X 100 FT	23116	23116C					
2 TO 1	3/32 X 100 FT	23332						
2 TO 1	1/8" X 100FT	23610			23610-OR	23610-BU		
2 TO 1	3/16" X 100FT	23611	23611C				23611GN	23611WH
2 TO 1	1/4" X 100 FT	23612						
2 TO 1	3/8" X 100 FT	23613						
2 TO 1	1/2" X 100 FT	23614		23614RD				
2 TO 1	5/8" X 100 FT			23618RD				
2 TO 1	3/4" X 100 FT	23615		23609R-100				
2 TO 1	3/4" X 330 FT			23615R-330	23615OR-330			23615WH-330
2 TO 1	1" X 100 FT	23616		23616RD				
2 TO 1	3" X 82 FT			23623R-82FT				
SINGLE WALL		NO ADHESIVE						
RATIO	OD X LENGTH	BLACK	CLEAR	RED	YELLOW	BLUE	GREEN	WHITE
2 TO 1	3/64" X 4'	23601						
2 TO 1	1/16" X 4'	23600-48BK			23600-48YE			
2 TO 1	3/32" X 4'		23602-CL					
2 TO 1	1/8" X 4'	23603	23603-CL	23603-RD				23603-WH
2 TO 1	3/16" X 4'	23604	23604-CL	23604-RD		23604-BU		
2 TO 1	1/4" X 4'	23605	23605-CL	23605-RD		23605-BU		23605-WH
2 TO 1	5/16" X 4'	23606						
2 TO 1	3/8" X 4'	23607	23607-CL	23607-RD		23607-BU		
2 TO 1	1/2" X 4'	23608		23608-RD				
2 TO 1	5/8" X 4'	23618-48B						
2 TO 1	3/4" X 4'	23609-48B		23609-48R				
2 TO 1	1" X 4'	23616-48B		23616-48RD			23616-48GR	
2 TO 1	1.5" X 4'	23620-48B		23620-48RD				
2 TO 1	2" X 4'	23619-48B						
DUAL WALL		ADHESIVE LINED						
RATIO	OD X LENGTH	BLACK	CLEAR	RED				
3 TO 1	1/8" X 660'	23710	23710C	23710R				
3 TO 1	3/16" X 330'	23711	23711C	23711R				
3 TO 1	1/4" X 330'	23712	23712C					
3 TO 1	1/4" X 100'			23712R-100				
3 TO 1	3/8" X 330'	23713	23713C	23713R				
3 TO 1	1/2" X 100'	23714	23714C	23714R				
3 TO 1	3/4" X 100'	23715	23715C	23715R				
3 TO 1	1" X 100'	23716	23716C	23716R				
DUAL WALL		ADHESIVE LINED						
RATIO	OD X LENGTH	BLACK		RED				
3 TO 1	1/8" X 4'	23525-48B		23525-48R				
3 TO 1	3/16" X 4'	23530-48B		23530-48R				
3 TO 1	1/4" X 4'	23535-48B		23535-48R				
3 TO 1	5/16" X 4'	23575-48B						
3 TO 1	3/8" X 4'	23540-48B		23540-48R				



3 TO 1	1/2" X 4'	23545-48B		23545-48R				
3 TO 1	3/4" X 4'	23550-48B		23550-48R				
3 TO 1	1" X 4'	23555-48B		23555-48R				
3 TO 1	1.25" X 4'	23560-48B						
3 TO 1	1.5" X 4'	23565-48B						
3 TO 1	2" X 4'	23570-48B						
DUAL WALL ADHESIVE LINED								
RATIO	OD X LENGTH	BLACK	CLEAR	RED				
3 TO 1	1/8" X 6"	23525-06B	23525-06C	23525-06R				
3 TO 1	3/16" X 6"	23530-06B	23530-06C	23530-06R				
3 TO 1	1/4" X 6"	23535-06B	23535-06C	23535-06R				
3 TO 1	3/8" X 6"	23540-06B	23540-06C	23540-06R				
3 TO 1	1/2" X 6"	23545-06B	23545-06C	23545-06R				
3 TO 1	3/4" X 6"	23550-06B	23550-06C	23550-06R				
3 TO 1	1" X 6"	23555-06B	23555-06C	23555-06R				
3 TO 1	1 1/4" X 6"	23560-06B	23560-06C	23560-06R				
3 TO 1	1 1/2" X 6"	23565-06B	23565-06C	23565-06R				
3 TO 1	2" X 6"	23570-06B	23570-06C	23570-06R				
HEAVY WALL								
3 TO 1	3/8" X 48"	23590-48B		23590-48R				
3 TO 1	3/4" X 6"	23591-06B		23591-06R				
3 TO 1	3/4" X 48"	23591-48B		23591-48R				

SHRINK TUBING CHART					
Tubing O.D.	Non Insulated	Vinyl/ Nylon	Copper Lugs	Heavy Duty Lugs	Battery Terminals
3/32"	26-24				
1/8"	22-18	26-24			
3/16"	16-14	22-18			
1/4"	12-10	16-14			
3/8"	8-6	12-10	8-6	8-4	
1/2"	4-2	8-6	4-1/0	1	4
3/4"	1/0-3/0	4-1/0	2/0-4/0	1/0-3/0	1-3/0
1"		2/0-3/0	250MCM	4/0	4/0

Heat Shrink Box Kits



Red & Black HS Box Kit

Part No.:
5990-74BR

6": (10) Black 1/8", (10) Red 1/8",
 (10) Black 3/16", (10) Red 3/16",
 (5) Black 1/4", (5) Red 1/4",
 (4) Black 3/8", (4) Red 3/8",
 (5) Black 1/2", (5) Red 1/2"
 (3) Black 3/4", (3) Red 3/4"



Black HS Box Kit

Part No.:
5990-62 BLACK

4": (20) 1/8", (20) 3/16", (10) 1/4",
 (5) 3/8", (5) 1/2", (2) 3/4"
 3:1 Shrink Ratio-UL & CUL.
 Certified at 600V 125 degree C
 temp. 90-120 degree C-UL FILE
 E333465 RoHS Compliant



Color HS Box Kit

Part No.:
5990-160 MULTI

4" Colors: Black, Blue, Clear, Green,
 Red, White, Yellow
 (60) 1/16", (35) 3/32", (25) 1/8",
 (20) 3/16", (10) 1/4", (10) 3/8"
 2:1 Shrink Ratio-UL & CUL.
 Certified at 600V 125 degree C temp.
 90-120 degree C-UL FILE E333465
 RoHS Compliant



Black HS Box Kit

Part No.:
5990-160 BLACK

4": (60) 1/16", (35) 3/32",
 (25) 1/8", (20) 3/16", (10) 1/4", (10)
 3/8"
 2:1 Shrink Ratio-UL & CUL.
 Certified at 600V 125 degree C temp.
 90-120 degree C-UL FILE E333465
 RoHS Compliant



Get quote >>

Angic Global Solutions

<https://www.AngicGlobal.com> Sales@AngicGlobal.com

1-888-872-0690

Heavy Duty Electrical Lugs

Unplated

Wire Size	Stud Size	Part No.	
8	10	8101-00#	
	1/4	8141-00#	
	5/16	8562-00#	
	3/8	8382-00#	
	1/2	8503-00#	
6	10	6101-00#	
	1/4	6141-00#	
	5/16	6562-00#	
	3/8	6382-00#	
	1/2	6503-00#	
4	10	4101-00#	
	1/4	4141-00#	
	5/16	4562-00#	
	3/8	4382-00#	
	1/2	4503-00#	
2	1/4	2141-00#	
	5/16	2561-00#	
	3/8	2381-00#	
	1/2	2503-00#	
1	1/4	1141-00#	
	5/16	1561-00#	
	3/8	1381-00#	
	1/2	1503-00#	
1/0	1/4	10141-00#	
	5/16	10561-00#	
	3/8	10381-00#	
	1/2	10501-00#	
2/0	1/4	20141-00#	
	5/16	20561-00#	
	3/8	20381-00#	
	1/2	20501-00#	
3/0	3/8	30381-00#	
	1/2	30501-00#	
	5/16	30561-00#	
4/0	3/8	40381-00#	
	1/2	40501-00#	

Plated

Wire Size	Stud Size	Part No.	
8	10	8101-60#	
	1/4	8141-60#	
	5/16	8562-60#	
	3/8	8382-60#	
	1/2	8503-60#	
6	10	6101-60#	
	1/4	6141-60#	
	5/16	6562-60#	
	3/8	6382-60#	
	1/2	6503-60#	
4	10	4101-60#	
	1/4	4141-60#	
	5/16	4562-60#	
	3/8	4382-60#	
	1/2	4503-60#	
2	1/4	2141-60#	
	5/16	2561-60#	
	3/8	2381-60#	
	1/2	2503-60#	
1	1/4	1141-60#	
	5/16	1561-60#	
	3/8	1381-60#	
	1/2	1503-60#	
1/0	1/4	10141-60#	
	5/16	10561-60#	
	3/8	10381-60#	
	1/2	10501-60#	
2/0	1/4	20141-60#	
	5/16	20561-60#	
	3/8	20381-60#	
	1/2	20501-60#	
3/0	1/4	30141-60#	
	5/16	30561-60#	
	3/8	30381-60#	
4/0	1/4	40141-60#	
	5/16	40561-60#	
	3/8	40381-60#	
	1/2	40501-60#	

8 - 4/0

8GA 1/4 8141-60-90#
 6GA 5/16 6562-60-90#
 4GA 3/8 4382-60-90#
 4GA 1/4 4141-60-90#
 4 GA 5/16 4562-60-90#
 2GA 5/16 2561-60-90#
 2/0 3/8 20381-60-90#
 3/0 3/8 30381-60-90#
 4/0 5/16 40561-60-90#
 Other Sizes Available

Metric & AWG Wire Size

mm ²	AWG
1	16
2	14
3	12
4-5	10
6-8	8
9-13	6
14-21	4
22-35	2
36-42	1
43-53	1/0
54-68	2/0
69-86	3/0
87-107	4/0

Plated

Wire Size	Part No.
8	8001-25#
6	6001-25#
4	4001-25#
2	2001-25#
1	1001-25#
1/0	10001-25#
2/0	20001-25#
3/0	30001-25#
4/0	40000-25#



Electrical Lugs



Get quote

Top Post Straights

Wire Size	Post Type	Part No.	Color Code
6 GA	Universal	C2101T	Gray
4 GA	Universal	C2102T	Gray
4 GA	Negative	C2103T	Gray
4 GA	Positive	C2104T	Gray
2 GA	Negative	C2105T	Green
2 GA	Positive	C2106T	Green
1 GA	Negative	C2107T	Pink
1 GA	Positive	C2108T	Pink
1/0	Negative	C2109T	Black
1/0	Positive	C2110T	Black
2/0	Negative	C2111T	Orange
2/0	Positive	C2112T	Orange
3/0	Negative	C2113T	Purple
3/0	Positive	C2114T	Purple
4/0	Negative	C2115T	Yellow
4/0	Positive	C2116T	Yellow



Top Post Right Angles (Flag)

1/0	Negative	C2209T	Black
1/0	Positive	C2210T	Black
2/0	Negative	C2211T	Orange
2/0	Positive	C2212T	Orange
3/0	Negative	C2213T	Purple
3/0	Positive	C2214T	Purple
4/0	Negative	C2215T	Yellow
4/0	Positive	C2216T	Yellow



Top Post Right Elbows

1/0	Negative	C2309T	Black
1/0	Positive	C2310T	Black
2/0	Negative	C2311T	Orange
2/0	Positive	C2312T	Orange
3/0	Negative	C2313T	Purple
3/0	Positive	C2314T	Purple
4/0	Negative	C2315T	Yellow
4/0	Positive	C2316T	Yellow



Top Post Left Elbows

1/0	Negative	C2409T	Black
1/0	Positive	C2410T	Black
2/0	Negative	C2411T	Orange
2/0	Positive	C2412T	Orange
3/0	Negative	C2413T	Purple
3/0	Positive	C2414T	Purple
4/0	Negative	C2415T	Yellow
4/0	Positive	C2416T	Yellow



3/8 Stud - Side Mount Straights

4 GA	Universal	C2602T	Green
1-2 GA	Universal	C2607T	Pink
1/0	Universal	C2609T	Black
2/0	Universal	C2611T	Orange
3/0	Universal	C2613T	Purple



Stud - Side Mount (Splice)

1/0	Universal	C2709T	Black
2/0	Universal	C2711T	Orange
3/0	Universal	C2713T	Purple



Exceeds SAE conductivity standards

Nuts and Bolts A. 5/16" x 18 x 1 1/4" - Standard for Above Parts
 Nuts and Bolts B. 5/16" - 18 x 1 1/2"



High temperature PVC construction
 rated at 190° F / 90° C.

Medium Duty Starter

Wire Size	Color	Part No.
8-2	Black	7001B
	Red	7001R



Alternator Caps

1-8-10	Black	7003B
	Red	7003R
6-2/0	Black	7703B
	Red	7703R



Straight Covers

8-6	Black	7006B
	Red	7006R
1/0	Black	7007B
	Red	7007R
2/0	Black	7008B
	Red	7008R
3/0	Black	7109B
	Red	7109R



Oval Covers

4/0	Black	5707B
	Red	5707R



Eyelet Insulator

2-2/0	Black	5735B
	Red	5735R
2/0-3/0	Black	5736B
	Red	5736R



Starter Eyelet Insulator

3/0	Red	7718R
-----	-----	-------



Terminal Insulator

Wire Size	Width x Height (Inches)	Part No.
18-10	.48 x .70	7009R
	.55 x .75	7010R
	.73 x .87	7011R
8-1	.48 x .70	7012R
	.55 x .75	7013R
	.65 x .80	7014R
	.73 x .87	7015R
	.81 x .95	7016B
	.81 x .95	7016R
2-2/0	.81 x .95	7017R
	.87 x 1.05	7018R
	.95 x 1.13	7019B
	.95 x 1.13	7019R
	1.20 x 1.40	7020R



Universal Marine Cap

This cap will swivel to accommodate the cable direction. For use with single or multiple cables up to 19mm (0.75")

4/0	7024R
-----	-------



Slimlines - 18 lb Tensile Strength

	Width	Tensile Strength	Clear Part No.	Black Part No.
4	.100	18	20564	20564B
5.5	.100	18	20561	20561B
8	.100	18	20565	20565B

Intermediate - 40 lb Tensile Strength

5.5	.140	40	20562	20562B
8.5	.140	40	20563	20563B

Standard - 50 lb Tensile Strength

7	.190	50	20568	20568B
11	.190	50	20566	20566B
14.5	.190	50	20567	20567B

Heavy Duty - 120 - 175 lb Tensile Strength

14.5	.300	120	20567X	20567XB
17.7	.350	120		20588XB
24	.350	175	20559X	20559XB
36	.350	175	20560X	20560XB

Mount Head - 50 lb Tensile Strength

7.5	.190	50	20557	20557B
-----	------	----	-------	--------



Releasable Tie

- Part # 20536 5" 50LB Release Clear
- Part # 20536B 5" 50LB Release Black
- Part # 20537 8" 50LB Release Clear
- Part # 20537B 8" 50LB Release Black
- Part # 20538 11" 50LB Release Clear
- Part # 20538B 11" 50LB Release Black
- Part # 20539 14" 50LB Release Clear
- Part # 20539B 14" 50LB Release Black

Cable Tie Cutter

Part No.
20710



Heavy Duty Cable Tie Tool

Part No.
20708
• Recommended use for
120-175 Lb. Wire Ties



Cable Tie Tool

Part No. 20609

- Automatically cuts excess cable ties flush
- Adjustable tension settings
- Recommended use for 18-50 Lb. Wire Ties



Adhesive Mount

Size	Color	Part No.
3/4 x 3/4	Clear	23060
3/4 x 3/4	Black	23060B
1 x 1	Clear	23061
1 x 1	Black	23061B



Battery Cables

Battery Cable is the OEM standard. Our battery cable meets or exceeds standards established by the Society of Automotive Engineers, (SAE). Battery cable, insulated with PVC, is flame retardant & resistant to fuel, oil, acid and salt. 50 volts

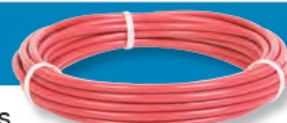

Gauge	Color Coded Stripe	Battery Cable with PVC insulation	
		Black	Red
8	Gray	58008-25B	58008-25R
6	Gray	58006-25B	58006-25R
4	Gray	58004-25B	58004-25R
2	Green	58002-25B	58002-25R
1	Pink	58001-25B	58001-25R
1/0	Black	58010-25B	58010-25R
2/0	Orange	58020-25B	58020-25R
3/0	Purple	58030-25B	58030-25R
4/0	Yellow	58040-25B	58040-25R

TRAILER CABLE	WIRE	FT	CONDUCTOR	COLOR
59124	12	100	4	BK,RD,BR,WH
59144-A	14	100	4	YL, RD, GR, BR
59144-B	14	100	4	WH, BR, YL, GR
59144-C	14	100	4	BK, RD, BR, WH
59164-A	16	100	4	YL, RD, GR, BR
59164-B	16	100	4	BK, RD, BR, WH
59126	12	100	6	RD, GR, BR, WH, BK, YL
59146-A	14	100	6	RD, BL, GR, YL, BR, BK
59146-B	14	100	6	RD, GR, BR, WH, BK, YL
59166-A	16	100	6	GR, BL, YL, BK, RD, BR
59166-B	16	100	6	RD, GR, BR, WH, BK, YL
59147	14	100	7	RD, GR, BR, WH, BK, YL, BL

GPT Primary Wire - Stranded



**100 ft
ROLL**

	8 GA	10 GA	12 GA	14 GA	16 GA	18 GA	20 GA
Purple		54100	54120	54140	54160	54180	
Black	54081	54101	54121	54141	54161	54181	54201
Orange		54102	54122	54142	54162	54182	
Green		54103	54123	54143	54163	54183	
White	54084	54104	54124	54144	54164	54184	
Brown		54105	54125	54145	54165	54185	
Pink		54106	54126	54146	54166	54186	
Red	54087	54107	54127	54147	54167	54187	54207
Blue		54108	54128	54148	54168	54188	
Yellow		54109	54129	54149	54169	54189	
Gray		54110	541210	541410	541610	541810	

80°C 60 Volt PVC Insulation

500 ft. and 1,000 ft. spools available on request

Made in the U.S.A.

Recommended Uses

- 10 GA For generator, heater switch, air conditioner, meter & panel lights
- 12 GA Light switches & ignition switches
- 14 GA Horn button circuit, head lights, gas gauge to coil & cigarette lighter
- 16 GA Header leads, gas gauge, directionals, stop signal & generator to starter
- 18 GA Single, bulb, low amp circuits & clock

Trailer Wire

(100 ft. Spools)

Wire Size	2 Conductor Black-Red
14	53142
16	53162
18	53182

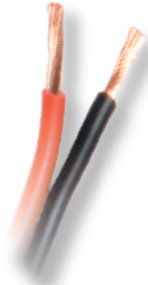

Jacketed Primary Wire

(100 ft. Spools)

Wire Size	2 Conductor Black-White
8	55082
10	55102
12	55122
14	55142
16	55162



Trailer Wire

(100 ft. Spools)

Wire Size	3 Conductor Brown-Green-Yellow
14	53143
16	53163
18	53183

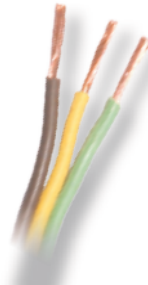

Jacketed Primary Wire

(100 ft. Spools)

Wire Size	3 Conductor Black-Green-White
10	55103
12	55123
14	55143
16	55163



Trailer Wire

(100 ft. Spools)

Wire Size	4 Conductor Brown-Green Yellow-White
14	53144
16	53164
18	53184



Jacketed Primary Wire

(100 ft. Spools)

Wire Size	4 Conductor Black-Green Red-White
10	55104
12	55124
14	55144
16	55164



Recommended for RVs, boats and utility trailers.

Recommended for auto, truck, agriculture, construction and light marine applications. Heavy Duty flat PVC outer jacket is abrasion resistant and protects against moisture, oil, acid & salt.



Get quote >>

Angic Global Solutions

1-888-872-0690

<https://www.AngicGlobal.com> Sales@AngicGlobal.com

Finger Grip Connectors

Rated to 105°C (221°F) 600 volt max

Wire Size	Min.	Max	Part No.
-----------	------	-----	----------

18-10	2 #18	3 #12	20584*
-------	-------	-------	--------



18-8	3 #16	5 #12	20586*
------	-------	-------	--------



18-8	3 #14 w/1 #18	3 #10	20588*
------	------------------	-------	--------



14-6	2 #10 w/1 #12	1 #8 w/3 #10	20589*
------	------------------	-----------------	--------



For a wider range of coverage

22-8	3 #22	4 #12	20509*
------	-------	-------	--------



Performance Plus Connectors

Rated 105°C (221°F) 300/600 Volt Max.
 Replaces eight standard connectors

22-12	2 #22	2 #12	20540*
-------	-------	-------	--------



18-8	2 #18	2 #8	20541*
------	-------	------	--------



14-8	4 #14	5 #12	20542*
------	-------	-------	--------



IDC Connectors - Gel Filled

P/N	Photo	Wire Gauge	Max OD	How to use
20528 Yellow		(22-26 AWG)	1.52mm	
20527 Orange		(18-26AWG)	2.08mm	
20526 Red		(19-26AWG)	1.67mm	
20525 Red		(19-26AWG)	2.08mm	

Screw On Connectors

Rated 105°C (221°F) 300/600 Volt Max.

Wire Size	Min.	Max	Part No.
-----------	------	-----	----------

22-14	2 #22	1 #16 w/1 #18	20501#
-------	-------	---------------	--------



22-14	2 #22	3 #16	20502#
-------	-------	-------	--------



22-14	1 #18 w/ 1 #20	4 #16 w/ 1 #20	20503#
-------	----------------	----------------	--------



22-10	3 #20	2 #12 w/ 2 #14	20504#
-------	-------	----------------	--------



22-10	3 #18	2 #20 w/2 #12	20506#
-------	-------	---------------	--------



Ceramic Connectors

Rated 1000°F Max. 600 V

22-14	1 #14 w/ 1 #16	2 #14	20543
-------	----------------	-------	-------

22-10	3 #14	2 #10	20544
-------	-------	-------	-------



18-8	3 #14 w/ 3 #16	2 #8	20545
------	----------------	------	-------

Winged Grounding Connector

Color coded GREEN for quick identification as a grounding conductor for copper wire only.
 Rated to 105°C (221°F) 1000 volt max

14-10	2 #14	5 #12	20583*
-------	-------	-------	--------



W/P Connector Kits

Part No.: 5990-34
 34 pc. Aqua W/P Connector Kit
 20580* - 20 pc.
 20581* - 10 pc.
 20582* - 4 pc.

Purchase Individually

20580 22-12 Orange W/P Connector
 20581 22-8 Red W/P Connector
 20582 14-6 Blue W/P Connector



Instant Tap Connectors



Rated 105°C 600 volts

75°C 300 volts

20510
 #20510UL import
 22-18 with stop

20500
 #20500J import
 18-14 with stop

20512
 #20512UL import
 18-14 no stop

20511
 #20511UL
 12-10 with stop

Flame Retardant
 #20517 no stop
 #20529 with stop
 18-14



WITH WIRE STOP



WITH NO WIRE STOP

Made in U.S.A

T-Tap Connectors



Rated 105°C 600 volts

Rated 105°C 600 volts

20513
 24-20

20514
 #20514UL
 22-16

20515
 #20515UL
 16-14

20516K
 #20516UL
 12-10

20514DB#
 22-16

20515DB#
 16-14

20516DB#
 12-10



IDC Connectors

Wire Size	Description	Part No.
22-14	Blue w/ Gel 3M 314 IMP	20518* 20518A#
22-14	Clear 3M 314U	20519+
22-16	Black w/Gel 3M 316IR	20520#

Misc. Connectors

Wire Size	Description	Part No.
18-14 / 12-10	Brown Dual Tap 3M 902 IMP	20521* 20521A#
22-16 / 12-10	Red Dual Tap 3M 558 IMP	20555+ 20555A#
18-16	Blue Tap w/ Gel 3M 804 IMP	20522+ 20522A#
18-16	Bullet Style Tap .157 Male 3M 901 IMP	20523+ 20523A#
18-16	Auto Fuse Holder 3M 972 IMP	20524 20524A#



Get quote >>

Angic Global Solutions

1-888-872-0690

<https://www.AngicGlobal.com>

Sales@AngicGlobal.com

Tap Connector

Fuse Puller

Length Part No.

1.3" 90500
 For Mini, Standard & Maxi Fuses



Length Part No.

2" 90600
 For Mini, Standard, Maxi Fuses & Glass Fuses



Length Part No.

4.1" 90700
 For Mini, Standard, Maxi Fuses & Glass Fuses



Micro Fuse Low Profile

Amp	Color	Part No.
5	Tan	63205
7.5	Brown	63207
10	Red	63210
15	Blue	63215
20	Yellow	63220
25	Clear	63225
30	Green	63230



LED Fuses

Mini Led Fuse	Color	Part No.
2	Gray	65002
3	Violet	65003
4	Pink	65004
5	Tan	65005
7.5	Brown	65007
10	Red	65010
15	Blue	65015
20	Yellow	65020
25	Clear	65025
30	Green	65030

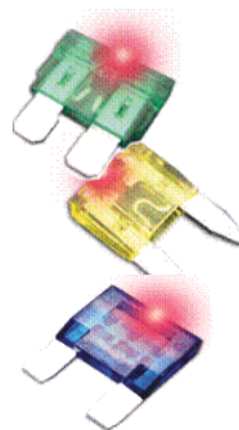

Mini Fuse

2	Gray	63002
3	Violet	63003
4	Pink	63004
5	Tan	63005
7.5	Brown	63007
10	Red	63010
15	Blue	63015
20	Yellow	63020
25	Clear	63025
30	Green	63030



Standard Fuse

1	Black	63101
2	Grey	63102
3	Violet	63103
4	Pink	63104
5	Tan	63105
7.5	Brown	63107
10	Red	63110
15	Blue	63115
20	Yellow	63120
25	Clear	63125
30	Green	63130
35	Purple	63135
40	Orange	63140



Standard Led Fuse

Standard Led Fuse	Color	Part No.
2	Gray	65102
3	Violet	65103
4	Pink	65104
5	Tan	65105
7.5	Brown	65107
10	Red	65110
15	Blue	65115
20	Yellow	65120
25	Clear	65125
30	Green	65130

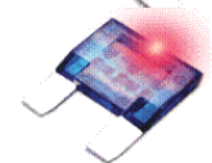

Maxi Fuse

20	Yellow	63420
30	Green	63430
40	Orange	63440
50	Red	63450
60	Blue	63460
70	Brown	63470
80	Clear	63480
100	Violet	63490



Micro2 Blade Type Fuses

Amp	Color	Part No.
5	Tan	66205
7.5	Brown	66207
10	Red	66210
15	Blue	66215
20	Yellow	66220
25	Clear	66225
30	Green	66230



Micro3 Blade Type Fuses

Amp	Color	Part No.
5	Tan	67305
7.5	Brown	67307
10	Red	67310
15	Blue	67315



Mini Fuse Holder w/ 12" wire

Wire Range	Part No.
12GA - Rated to 30 Amp	90012
14GA - Rated to 20 Amp	90014
16GA - Rated to 10 Amp	90016
18GA - Rated to 5 Amp	90018



Standard Holder w/ 12" wire

12GA - Rated to 30 Amp	90312
14GA - Rated to 20 Amp	90314
16GA - Rated to 10 Amp	90316
18GA - Rated to 5 Amp	90318



Standard Holder w/ 8" wire

10GA - Rated to 40 Amp	90110
12GA - Rated to 30 Amp	90112
14GA - Rated to 20 Amp	90114
16GA - Rated to 10 Amp	90116
18GA - Rated to 5 Amp	90118



Maxi Fuse Holder w/ 12" wire

8GA - Rated to 60 Amp	90408
10GA - Rated to 40 Amp	90410



Standard Holder w/ 12" wire

10GA - Rated to 40 Amp	90210
12GA - Rated to 30 Amp	90212
14GA - Rated to 20 Amp	90214
16GA - Rated to 10 Amp	90216
18GA - Rated to 5 Amp	90218



Add-A-Circuit

Mini Fuse 16 Ga 10 Amp	90515
Standard Fuse 16 Ga 10 Amp	90516
Micro2 16 Ga 10 Amp	99510
Micro3 16 Ga 10 Amp	99516
Low Profile 16 Ga 10 Amp	99515



Micro2 Blade Fuse Holder

12GA - Rated to 30 Amp	99230
14GA - Rated to 20 Amp	99220
16GA - Rated to 10 Amp	99210
18GA - Rated to 5 Amp	99205



Micro3 Blade Fuse Holder

14GA - Rated to 20 Amp	99314
16GA - Rated to 10 Amp	99316



Waterproof Fuse Holders w/12" wire

12GA - W/P Mini 30 Amp	90512
14GA - W/P Mini 20 Amp	90514
12GA - W/P Standard 30 Amp	90412
14GA - W/P Standard 20 Amp	90414



Split Loom

I.D. Size	Part No.
1/4" X 25,000 FT	56014
1/4" X 1000 FT	56014-1M
1/4" X 50 FT	56014-50
1/4" X 500 FT	56014-5C
1/4" X 100 FT	56014-C
1/4" X 100 FT BOX	56014-CBOX
3/8" X 15,000 FT	56038
3/8" X 1,000 FT	56038-1M
3/8" X 50 FT	56038-50
3/8" X 500 FT	56038-5C
3/8" X 100 FT	56038-C
3/8" X 100 FT BOX	56038-CBOX
1/2" X 8,500 FT	56050
1/2" X 1,000 FT	56050-1M
1/2" X 50 FT	56050-50
1/2" X 500 FT	56050-5C
1/2" X 100 FT	56050-C
1/2" X 100 FT BOX	56050-CBOX
5/8" X 6,000 FT	56058
5/8" X 50FT	56058-50
5/8" X 500FT	56058-5C
5/8" X 100 FT	56058-C
5/8" X 100FT BOX	56058-CBOX
3/4" X 4,200 FT	56075
3/4" X 1,000FT	56075-1M
3/4" X 50 FT	56075-50
3/4" X 500FT	56075-5C
3/4" X 100FT	56075-C
3/4" X 100FT BOX	56075-CBOX
7/8" X 3,000 FT	56085
1" X 3,000 FT	56100
1" X 25FT	56100-25
1" X 50FT	56100-50
1" X 100FT	56100-C
1" X 100FT BOX	56100-CBOX
1 1/4" X 1,800FT	56125
1 1/4" X 100FT	56125-C
1 1/2" X 1,800FT	56150
1 1/2" X 100FT	56150-C
2" X 100FT	56200-C

- Provides a Neat Appearance
- Insulates and Protects Wire
- Easy Insulation
- Polyethylene
- -40° to +185° F



Spiral Wrap

I.D. Size	Part No.
1/8"	57012
1/4"	57025
3/8"	57038
1/2"	57050
3/4"	57075
1"	57100

- Insulates and Protects Wire
- Bundle Multiple Wires For A Neat Installation
- Wires Can Be Fed Through The Wrap To Different Locations



Cutting Tools

Part No.	Description
20774	Cutting Tool for Loom & Wrap
10774	Replacement Blade



Accessories

Part No.	Description
73181	Solder - 16 oz. spool, 1/8" dia. 40/60 tin/lead
73183	Solder Flux - 4 oz. zinc chloride solder paste flux
73185	Quick Flux - Cleans and prepares surface
73187	Dielectric Grease - 5oz. Tube
73188	Dielectric Grease - 2 gram pillow pack



Solder Pellets

Pre-measured solder pellets ensure the right amount of solder for each connection

Part Number	Wire Size	Color Stripe
SP-6	6 GA	Grey
SP-4	4 GA	Grey
SP-2	2 GA	Green
SP-1	1 GA	Pink
SP-1-0	1/0	Black
SP-2-0	2/0	Orange
SP-3-0	3/0	Purple
SP-4-0	4/0	Yellow

Miscellaneous Tools

Wire Stripper

Wire Size	Length	Lbs.	Part No.
26-10	8"	.66#	20604



Cable Cutter

Wire Size	Length	Lbs.	Part No.
20-4/0	8"	.66#	20605



Cutter/Stripper

Size	Length	Lbs.	Part No.
24-12	5"	.16#	20607



QuickStrip Cable Stripper

Part No.	Features
20706	<ul style="list-style-type: none"> • Strips up to 4/0 gauge • Includes spare blade • Only 5 1/2" long



Nylon Clamps

Screw Size	Max Bundle	Part Number
8	.12	23427
8	.25	23429
8	.50	23434



Steel Cushioned Clamps

Screw Size	Max Bundle	Part Number
1/4	.250	23436#
1/4	.375	23438
1/4	.500	23440
1/4	.625	23441
1/4	.750	23443
1/4	.875	23442
1/4	1.00	23444
1/4	1.25	23445



Ratchet Controlled

Gives the same results whenever you use them



20591*
 Non-Insulated 22-8 ga.
 Length 10.8" Lbs. 1#



20592*
 Insulated 22-14 ga.
 Length 9.7" Lbs. 1.1#



20593*
 Insulated 12-10 ga.
 Uninsulated 8 ga.
 Length 12.8" 2.02#



20594
 Insulated 22-18 & 16-14
 Flags Part # 20188 & 20189



20595
 Insulated 22-10 Female QDC
 Length 8.875" Lbs. 1.2#



20700
 Insulated 22-10 ga. Female
 Length 9" Lbs. 1.2#



20608Y (yellow)
 20608R (red)
 Insulated 22-10 ga.
 Length 9.5" Lbs. 1.27#

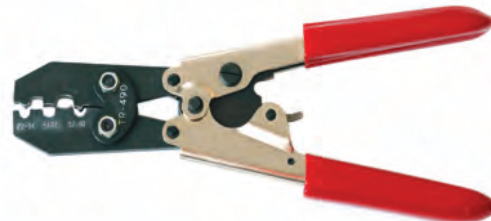

TR-490
 Insulated & Non-Insulated 22-10 ga.
 Nylon, Vinyl, Butted, or Brazed



20704 Insulated Flag 16-10 ga. 20705 Insulated Flag 22-14 ga. 20713 Non-Insulated Flag 22-14 ga.



20709
 Closed End Connectors 22-10 ga.

* UL & CSA listed tools with Hillsdale's Terminals

Hand Crimpers



20600
Upfront Stripper
22-10 ga.
Length 9.25" Lbs. 1.3#



22601
Upfront Crimper
26-8 ga.
Length 8.25" Lbs. .72#



20597
Crimper
22-10 ga.
Length 9" Lbs. .7#



20716
Multi-Function Crimping Tool
Cuts/Strips/Crimps
22-10 ga.
Non and Insulated Terminals, Flag Terminals, Bolts,
W/ Pliar Tip and Spring Loaded Handle
Length 8-5/8"



20717
3 Pc. Tool
22-10 ga.



20603
Econo Crimper
22-10 ga.
Length 7.5" Lbs. .66#

Heat Shrink Torches & Tools



20606
Mini Torch
Refillable Lighter
Electronic Igniter



20590
Butane Torch
Interchangeable Tips
120 min. of operation



20596
Heat Shrink Insulated
Ratchet Controlled Crimper
20-8 ga.
Length 11" Lbs. 1.2#



20715
Heat Shrink Butt Connectors
Ratchet Controlled Crimper
22-8 ga.
Length 9" Lbs. 1.2#

HexCrimp Sr.™

- Part No. 20701
- Hand-held 26" overall length
 - Crimps all major brands of connectors
 - 8 GA - 250 mcm
 - Made in USA



Quick Cutter 2™

- Part No. 20703
- Cuts cable up to 250 MCM (6/0GA)
 - 22" handles for easier cutting
 - Blades made of 1075 carbon steel, heat treated for long life can be resharpened
 - Made in USA



The Crimp Master

- Part No. 20599
- 24" Length
 - Crimps 8 - 4/0
 - Triangular crimp
 - Made in USA



6-2 Ga. UL Tool

- Part No. 6220CT*
- 18" Length
 - Crimps 6-2 ga.
 - Uninsulated
 - Made in the USA



Brute Hammer Crimper

- Part No. 20707
- Inexpensive, simple crimping tool
 - Use with hammer or vise
 - Crimps 8 thru 4/0 gauge connectors
 - Spring loaded pin locks in "up" position for loading connector and cable, when released pin holds connector securely during crimping



Parallel Connectors

Bare Seamless

Wire Size	Part No.
22-18	10647
16-14	10648
12-10	10649
8	10650
6	10651
4	10652
2	10653



*Only one crimp needed to complete splice



2 Pc. Nylon

Wire Size	Part No.
22-18	20647N
16-14	20648N
12-10	20649N
8	20650N
6	20651N



Vinyl Insulated

Wire Size	Part No.
22-18	20647
16-14	20648
12-10	20649
8	20650



Heat Shrink

Wire Size	Part No.
22-18	40647
16-14	40648
12-10	40649
8	40650



Adapters

Double Male Single Female Brass

10664[^]
10664 PLTD



3-Way Adapter Brass

10665
10665 Plated



Chair Adapter Brass

10667



2-Way Bullet Receptacle

10668



Insulated Double Male 75°C 300 volts

10670
10670-L



Insulated Triple Male 75°C 300 volts max

10671



ATO Fuse Tap Brass

10672
10672-mini



Glass Fuse Tap Brass

10673



All Adapters have .250 tabs, except the 2-Way Bullet Receptacle which has a .157 Tab

Ferrule Wire Ends

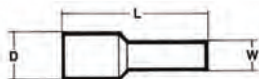

Wire Size	Color	Part No.	Dimensions
22	White	10822+	.551 x .051 x .122
20	Blue	10820+	.551 x .061 x .130
18	Red	10818+	.551 x .061 x .138
16	Black	10816+	.551 x .083 x .157
14	Gray	10814+	.551 x .102 x .185
12	Orange	10812+	.669 x .134 x .213
10	Green	10810+	.787 x .161 x .272
6	Blue	10806 [^]	

* Copper Ferrule with nylon insulation
Temp Range - 40° c up to 105° c



Crimps 22-10
Part # 20598
Length 9.3"

The MCTM-101



Our mylar tape fed products are universally spaced and can be applied with the MTCM - 101 and other standard electric applications.

The MCTM - 101 is heavy duty, durable and simple to operate. Powered by 85-100 PSI air pressure and 110 VAC. Fully automatic and foot actuated.

The MCTM - 101 machine comes with three sets of dies. One set for each size: 22-18, 16-14 and 12-10 gauge. Each die crimps bare, vinyl, and heat shrink.

8 ga. die available

MTCM-101		22-8 GA MYLAR TAPE CRIMP MACHINE
MTCM-102	1 SET (2 PCS)	22-18 U/I CRIMP DIES DIMPLE CRIMP OPTION
MTCM-103	1 SET (2 PCS)	16-14 U/I CRIMP DIES DIMPLE CRIMP OPTION
MTCM-104	1 SET (2 PCS)	12-10 U/I CRIMP DIES DIMPLE CRIMP OPTION
MTCM-109	1 SET (4 PCS)	22-18 INS CRIMP DIES - OEM
MTCM-110	1 SET (4 PCS)	16-14 INS CRIMP DIES - OEM
MTCM-111	1 SET (4 PCS)	12-10 INS CRIMP DIES - OEM
MTCM-112	1 SET (4 PCS)	12-10 FULLY INS CRIMP DIES
MTCM-113	1 SET (4 PCS)	8 GA V/I CRIMP DIES
MTCM-114	1 SET (2 PCS)	8 GA U/I HEX CRIMP DIES

FOR SPARE PARTS PLEASE CALL

Machine Specifications:



- Most rings, spades and butt connectors can be ordered by adding "MT" as a suffix. Call customer service with questions.

Weight 70 Lbs.
 Air: 1/4" NPT Inlet
 Stroke Rate: 1000 SPH
 Foot Pedal: Momentary switch. 5ft. cord
 Dimensions: 12" Wide - 20" Deep - 17"
 Height Electrical: 110V 5 ft. grounded standard plug
 Reel Size: 14" outside dia reel with 3/4" core
 Built in counter
 Operates with PLC programmable controller
 Buzzer to alert operator of machine malfunction
 Index feature for single or double spaced terminals

Vinyl Electrical Tape



Length	Description	Part No.	Length	Description	Part No.
3/4 x 60'	Black 7 mil	TAPE-BK	3/4 x 60'	White 7 mil	TAPE-WH
3/4 x 60'	Blue 7 mil	TAPE-BL	3/4 x 60'	Yellow 7 mil	TAPE-YL
3/4 x 60'	Green 7 mil	TAPE-GN	3/4 x 60'	Brown 7 mil	TAPE-BR
3/4 x 60'	Orange 7 mil	TAPE-OR	3/4 x 66'	3M Super 33 7 mil	TAPE-33
3/4 x 60'	Red 7 mil	TAPE-RD	3/4 x 66'	3M Super 88 8.5 mil	TAPE-88

Wire Processing

Call about our wire processing capabilities. We have added cutting and stripping abilities to go along with the crimp machine. Let us cut and strip your wires, cutting to length, full or partial strip and window stripping available for low runs. Simple harnesses, using Hillsdale connectors can now be done in house.

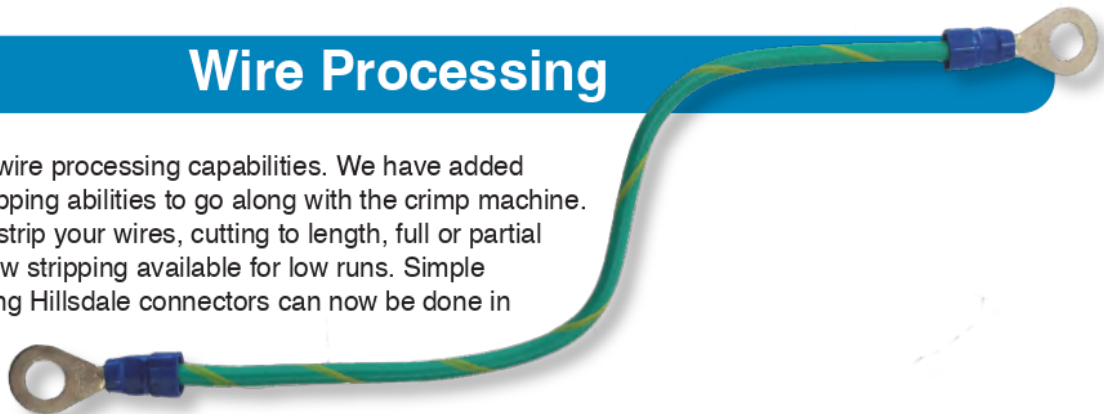

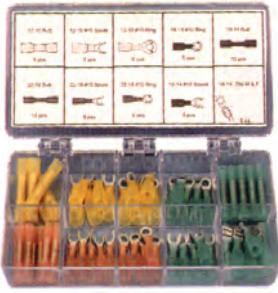

65 PC Heat Shrink Assortment
 Part # 5990-65 7 x 3.5"

- 10 pcs. - 16-14 & 22-18 Butt Splice
- 5 pcs. - 12-10 Butt Splice
- 5 pcs. - 22-18, 16-14 & 12-10 Ring 10
- 5 pcs. - 22-18, 16-14 & 12-10 Spade 10
- 5 pcs. - 16-14 .250 QDC M/F



140 PC Heat Shrink Butt Connector Kit
 Part # 5990-140 8 x 4.5"

- 50 pcs. - 22-18 butt
- 75 pcs. - 16-14 butt
- 15 pcs. - 12-10 butt



68 PC Heat Shrink Tubing Kit
 Part # 5990-68 8 x 4.5"

- 20 pcs. - Red 3/16" x 1.5"
- 20 pcs. - Blue 1/4" x 1.5"
- 10 pcs. - Yellow 5/16" x 1.625"
- 10 pcs. - Red 3/8" x 1.875"
- 5 pcs. - Black 3/8" x 2"
- 3 pcs. - Black 1/2" x 3"



38 PC Heat Shrink Tubing Kit
 Part # 5990-38 11 x 6.5"

- 10 pcs. - Red 3/16"
- 10 pcs. - Blue 1/4"
- 5 pcs. - Yellow 5/16"
- 5 pcs. - Black 3/8"
- 5 pcs. - Black 1/2"
- 3 pcs. - Black 3/4"



18 X 12"



9 X 13"

480 PC Assortment Kit
 Vinyl or Heat Shrink
 Part # 5990-480VP = Vinyl Plastic Kit
 Part # 5990-480VM = Vinyl Metal Kit
 Part # 5990-480HSP = Heat Shrink Plastic Kit
 Part # 5990-480HSM = Heat Shrink Metal Kit

- 20 pcs. - 22-18, 16-14 & 12-10 Butt
- 20 pcs. - 22-18, 16-14 & 12-10 Spades #10
- 20 pcs. - 22-18 Rings #10, 1/4, 5/16 & 3/8
- 20 pcs. - 16-14 Rings #10, 1/4, 5/16 & 3/8
- 20 pcs. - 12-10 Rings #10, 1/4, 5/16 & 3/8
- 20 pcs. - 22-18, 16-14 & 12-10 .250 QDC M/F



706 PC Heat Shrink Kit w/ Ratchet Tool
 Part # 5990-706 18.5" x 12"

- 50 pcs. - 22-18 & 16-14 butt
- 30 pcs. - 12-10 butt
- 15 pcs. - 8 ga. butt
- 10 pcs. - Rings 22-18, 16-14, 12-10, Stud Sizes 6, 8, 10, 1/4, 5/16, 3/8
- 15 pcs. - Rings 8 ga., #10, 3/8
- 10 pcs. - Spades 22-18, 16-14, 12-10, Stud Sizes 6, 8, 10
- 25 pcs. - QDC Male & Female .250, 22-18, 16-14, 12-10
- 15 pcs. - 16-14 Male & Female .157
- 10 pcs. - QDC Male & Female .250, Fully Insulated, 22-18, 16-14, 12-10
- 10 pcs. - Step Down butts, 16-14 to 22-18, 12-10 to 16-14
- 1 - Ratchet Tool (Part No. - 20596)
- 4 - Crimp Nest



190 PC Closed End Connector Kit
 Part No.: 5990-190

- 20569 - 100 pc.
- 20570 - 60 pc.
- 20571 - 20 pc.
- 20572 - 10 pc.



76 PC Closed End Connector Kit
 Part No.: 5990-76

- 20569 - 40 pc.
- 20570 - 20pc.
- 20571 - 10 pc.
- 20572 - 6 pc.





100 PC Mini Fuse Kit
Part # 5990-100 7 x 3.5"

20 pcs. - 10 amp
10 pcs. - 3, 4, 5, 7.5, 15, 20, 25 & 30 amp



60 PC Standard Fuse Kit
Part # 5990-60 7 x 3.5"

10 pcs. - 25 amp
5 pcs. - 3, 4, 5, 7.5, 10, 15, 20, 30, 35 and 40 amp



20 PC Maxi Fuse Kit
Part # 5990-20 7 x 3.5"

2 pcs. - 30, 70, 80 & 100 amp
4 pcs. - 40, 50 & 60 amp



130 PC Micro Fuse Low Profile Kit
Part # 5990-130

10 pcs. - 5 & 7.5 amp
20 pcs. - 10, 15, 25 & 30 amp
30 pcs. - 20 amp



55 PC Instant Tap Connector Kit
Part # 5990-55 8 x 4.5"

10 pcs. - 22-18 Red
25 pcs. - 18-14 Blue
10 pcs. - 18-14 White
10 pcs. - 12-10 Yellow



120 PC Screw On Connector Kit
Part # 5990-120 8 x 4.5"

40 pcs. - 22-16 Grey
30 pcs. - 22-14 Blue
20 pcs. - 22-14 Orange
15 pcs. - 18-12 Yellow
10 pcs. - 18-10 Red
5 pcs. - 14-8 Grey



180 PC Solderless Quick Connector Kit
Part # 5990-180 11 x 6.5"

10 pcs. ea. of the following:
22-18 & 16-14 .250 NI Flag
22-18 & 16-14 .250 V/I Male
22-18 & 16-14 .110, .187, .205 & .250 V/I
Female 22-18 & 16-14 .250 Fully Insulated
Male & Female 12-10 .250 V/I Male & Female



175 PC Assortment
Part # 5990-175N = Nylon
Part # 5990-175V = Vinyl
11 x 6.5"

4 pcs. - 12-10 Butt Splice
11 pcs. - 16-14 Butt Splice
11 pcs. - 22-18 Butt Splice
4 pcs. - 12-10 Rings #10 & 3/8
11 pcs. - 16-14 Rings #6, #8 & #10
9 pcs. - 16-14 Ring 1/4
11 pcs. - 16-14 Spades #6, #8 & #10
11 pcs. - 16-14 .250 QDC Male & Female
11 pcs. - 22-18 Ring #10
11 pcs. - 22-18 Spades #6 & #10
11 pcs. - 22-18 .250 QDC Female



240 PC Terminal Kit with Tool
Part # 5990-240N = Nylon
Part # 5990-240V = Vinyl
11 x 6.5"

1 pc. - Economy Crimper (Part No. - 20603)
20 pcs. - 12-10 Butt Splice
20 pcs. - 16-14 Butt Splice
20 pcs. - 22-18 Butt Splice
10 pcs. - 12-10 Rings #8, #10, 5/16 & 3/8
10 pcs. - 12-10 Spades #6 & #10
10 pcs. - 16-14 Rings #6 & #10
10 pcs. - 16-14 Spades #6 & #10
10 pcs. - 16-14 .250 QDC Male & Female
10 pcs. - 22-18 Rings #6 & #10
10 pcs. - 22-18 Spades #6 & #10
10 pcs. - 22-18 .250 QDC Male & Female



2400 PC Starter Kit
Part # 5990-2400N = Nylon
Part # 5990-2400V = Vinyl
Metal Box 18.5 x 12"

100 pcs. - 22-18 Rings, Stud Size #8, 10, 1/4, 5/16
100 pcs. - 16-14 Rings #10, 1/4, 5/16, 3/8
100 pcs. - 12-10 Rings #10, 1/4, 5/16, 3/8
100 pcs. - 22-18, 16-14, 12-10 Butt
100 pcs. - 22-18, 16-14, 12-10 Spade #10
100 pcs. - 22-18, 16-14, 12-10 Male 1/4
100 pcs. - 22-18, 16-14, 12-10 Female 1/4



170 PC Butt Connector Kit
Part # 5990-170 7 x 3.5"

25 pcs. - 12-10 Vinyl & Nylon
30 pcs. - 16-14 Vinyl & Nylon
30 pcs. - 22-18 Vinyl & Nylon



Get quote >>

Angic Global Solutions

1-888-872-0690

<https://www.AngicGlobal.com> Sales@AngicGlobal.com