

STANLEY[®]
Engineered Fastening

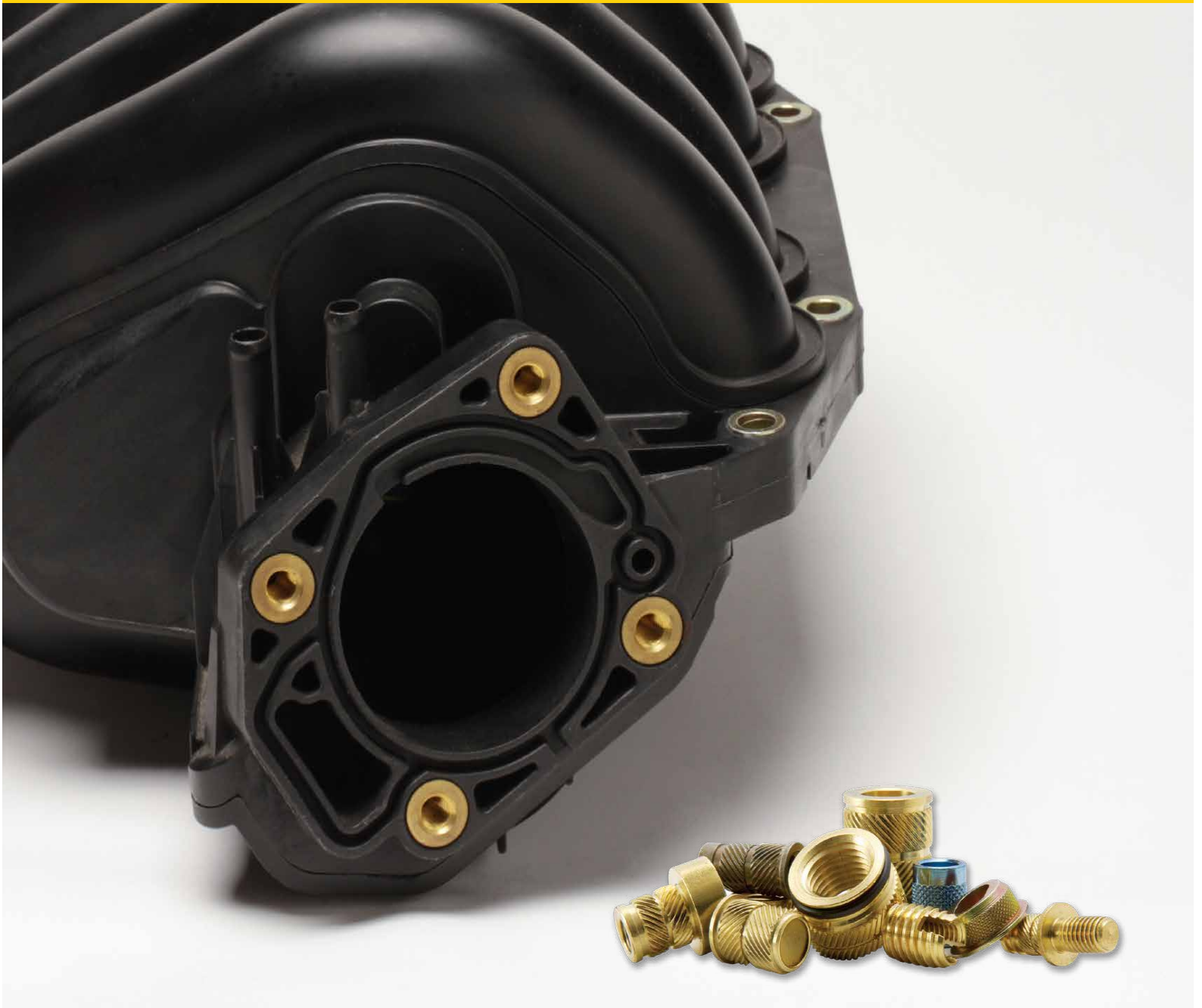

Fastening Solutions for Plastics

Dodge[®]



Get quote >>

Angic Global Solutions

1-888-872-0690

<https://www.AngicGlobal.com> Sales@AngicGlobal.com



Dodge® Inserts

Dodge inserts for plastics are the most widely recognized and highly regarded products in the fastening market. Since the 1950's, Dodge has been identified as the leader in its industry which can largely be attributed to its focus on providing high quality products.

Plastic Parts, Metal Threads

Threaded Inserts

Dodge inserts are designed to provide the high performance strength values of molded-in inserts while retaining all of the economical advantages of insert installation after molding.

Compression Limiters

Dodge non-threaded bushings expand the Dodge offering and are custom designed for your specific application. The Limiters can be pressed in or installed with either heat or ultrasonics. They are designed to minimize any cracking of plastic parts due to bolt load.

Engineering

Dodge Sales Engineers have broad experience in insert technology and are available to provide answers to any of your technical questions. Our highly trained Applications Engineering staff in Danbury, Connecticut will be glad to furnish technical assistance, compile test data, prepare samples for your evaluation and make specific recommendations on insert designs, installations and assembly systems. Our fastening experience and expertise is available for designing special inserts for unique or critical applications.

Quality

Dodge products are manufactured to the same exacting quality systems required by the military, aerospace and automotive standards. The Danbury manufacturing facility has been certified ISO/TS 16949: 2009 and ISO 14001. We are committed to an ongoing and never ending process of quality improvement and total customer satisfaction.

Table of Contents

	Page
Introduction to Dodge Products	2
Design Guidelines	4-7
Applications	8-9
Dodge Capabilities	10
Testing Terminology	10
Troubleshooting Guide	11
<hr/>	
Insert Selection Guide: Specifications & Test Data	
Ultrasert [®] I	12-13
Ultrasert [®] II	14-15
Ultrasert [®] II Screw Lock	16-17
Ultrasert [®] III	18-19
Ultrasert [®] IV	20-21
Ultrasert [®] IV Flanged	22-23
Ultraseal [®]	24
Ultra-Mold [®]	25
Miniature	26
Expansion, Standard	27
Expansion, Clinch	28
Expansion, Flanged	29
Self Threading	30
Self Threading, Flanged	31
Spred-Lok	32
TaperTuff [®]	33
Compression Limiters	34

The test data included in this catalogue should be considered as average values for the general families of plastics indicated.
 Critical application requirements may necessitate further specific testing.
 As a result of continuous design improvement, Dodge products are subject to modification.
 Current technical data and drawings are available upon request.

Design Guidelines

1. Plastic Overview

The two main categories of plastics where threaded inserts are used:

a. Thermoset Plastics

Thermoset plastics cannot be re-melted using heat or pressure once they are formed into their desired shape. These plastics tend to be hard and brittle. Since they will not re-melt, inserts installed by heat or ultrasonic can't be used in these materials. Recommended insert types include:

- » Self-Threading » Expansion » Press-In designs

Thermoset Types

- » Phenolic » Epoxies » Vulcanized rubber » Polyamide

b. Thermoplastics

Thermoplastic materials can be re-melted and re-formed once formed into their desired shape.

Heat and Ultrasonically installed inserts perform best in thermoplastic types of materials however Self-Threading, Expansion and Press-in style inserts may also be utilized in these materials.

Thermoplastics Types

- » ABS » PVC » Polycarbonate » Nylon

Fills (Additives)

Thermoplastic materials may be unfilled or may have a wide variety of fillers added to them to increase the stiffness or toughness properties of the material for specific applications. These fillers may include nylon or carbon fiber, mineral or even metal.

2. Insert Characteristics

Dodge Inserts for Plastics are designed to provide the strength necessary to allow bolts and screws to be tightened to the levels required to stretch the fastener and maintain a sufficient bolted joint assembly.

The insert must also provide resistance to rotation and pull-out under a wide variety of load and atmospheric conditions in a given assembly.

The optimum insert design depends on several factors including:

- » Plastic resin
- » Type and percentage of fill
- » Preferred insert installation method
- » Application strength requirements
- » Environmental concerns

3. Material And Plating

Material

Dodge inserts are traditionally made from 360 brass which falls under the designation UNS C36000 ½ hard free-cutting brass. The CDA specification is C360, ½ hard per ASTM B-16.

Dodge inserts are also available in alternate materials including Steel and Aluminum. Contact Applications Engineering for further information.

Plating

Inserts and Compression

Limiters may be processed with a variety of finishes from nickel plates and automotive finishes to colored dyes to distinguish insert types or installations.

Please consult our Applications Engineering team for assistance with your requirements.

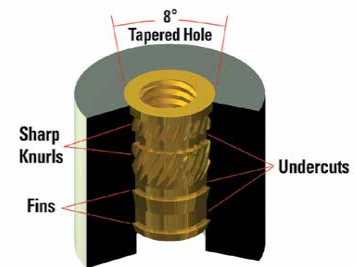

4. Insert Geometry

a. Undercuts

To accommodate the best overall balance of rotational and pull-out strength of an insert, the knurl bands are combined with undercuts, fins or a combination of both.

b. Knurl Patterns

The most common design methods used to increase rotational strength of an insert include increasing body diameter or increasing or changing the knurl pattern on a given insert design. The rotational resistance of an insert design can change dramatically by altering the coarseness or fineness of a knurl.

Coarser knurl patterns can provide a significant increase in rotational strength but can also induce significant stress into the insert/plastic assembly which could ultimately lead to cracking and premature failure.



» Diamond Knurls

Generally the most effective when the insert design is large and the knurl is coarser.

» Helical Knurls

While normally not as aggressive as a straight knurl, they are the more common solution. These knurls will provide adequate resistance to insert rotation.

» **Straight Knurls**

Effective in applications focused on high rotational strength.

» **Multiple Knurls**

It is common practice to utilize more than one knurl style and direction on the same part to reach the most optimum combination of rotational and torque resistance.

c. Tapers

To eliminate installation issues, many inserts are designed to be installed into a tapered hole. This allows for the insert to “self-align” during installation and requires less heat energy as the mass of plastic resin that is required to melt is less than with other hole designs. A tapered insert must always be used in a tapered hole.

d. Flanges

In certain applications, it is advantageous to have a large bearing surface to distribute the load applied when fastening mating parts. A large flange not only increases the bearing surface but also allows for adjustment of the mating part without a negative effect on insert strength.

e. Custom Capabilities

Dodge Threaded Inserts can also be custom designed for specific applications. Examples include undercut configurations, closed ends, platings, flange modifications, etc. Contact your Sales Engineer or Applications Engineering at (866) 364-2781 for assistance.

5. Best Practices

a. Hole Preparation Considerations

Each Style of insert listed throughout the catalogue features the recommended hole preparation dimensions.

- » **Hole Preparation Method** – Molded holes are the preferred method of hole preparation. A barrier of denser material is formed around the internal surface of the hole resulting in a stronger assembly.
- » **Recommended Hole Diameter** – Proper hole preparation is crucial in obtaining maximum strength results. Oversize holes will result in a degradation of strength and undersize holes can potentially result in the cracking of the parent material. Deviations from the recommendations may prove necessary dependent upon plastic / fill combinations. The general rule of thumb is to increase the hole diameter by 0.003 inch if the fill is between 15% and 35%.

Straight vs. Tapered Holes - Straight hole preparation allows for a taper that should not exceed a 1 degree included angle. Tapered holes require an 8 degree included angle. Tapering permits easy release of the core pin, aids in insert alignment, which in turn reduces installation time.

- » **Counterbores** – Traditionally are not recommended as they may interfere with proper insert alignment. Self threading inserts, or flanged inserts which should be installed flush, are the exception to the rule.

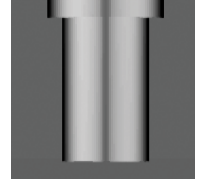

- » **Recommended Hole Depth** - Allows for proper insert set down (flush to 0.005 inch below the surface), prevents excessive flash, and prevents back filling of plastic from entering bottom threads.

» **Flanges**

In some applications, a large flange insert is installed from the opposite end of the part and when the screw or bolt is assembled, the tensile load is applied to the flange, increasing resistance to pull-out.

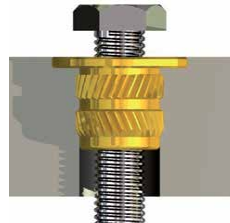

Typical Flange Installation



Optional Flange Installation

b. Boss Diameter/Wall Recommendations

Traditionally a boss diameter is two times the insert diameter for inserts 1/4" and under, 3mm wall thickness applies for all inserts that are larger. Exceptions include applications incorporating supported bosses, reinforced materials, and heat installation. Special consideration should be given to cold press installations where stress will be increased and will require larger boss diameters.

c. Assembly Guidelines For Mating Parts

Clearance Holes – It is important that the insert bear the load and not the plastic to avoid jacking the insert out. The mating component hole should be smaller than the face of the insert yet allow the connecting threaded fastener ample space to function normally.

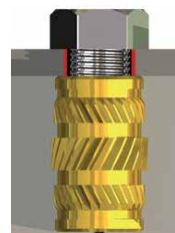

Correct

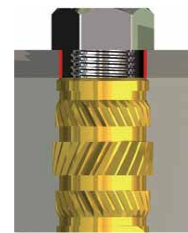

Incorrect

Design Guidelines

d. Compression Limiters Considerations



Strength – The head of the bolt being used in the assembly must seat against the compression limiter to avoid potential failure due to plastic creep.

Mating Components – The mating component must also withstand the stress generated by the clamping force. In instances where the mating component will also be plastic, the use of a secondary insert should be considered.

Types of Applications

Structural

- » Insert is equal to or larger than the flange
- » Provides higher axial strength
- » Failure mode is the bolt

Non-Structural

- » Insert is smaller than the flange
- » Has simple OD configuration
- » Applies to smaller inserts under 1/2" OD

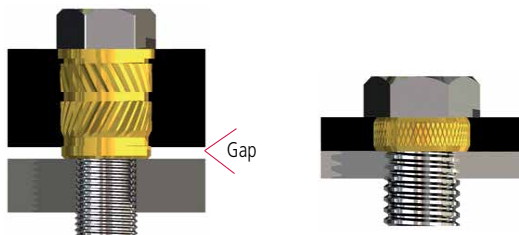

Structural

Non-Structural

Note: Gap allows for a gasket, (e.g., manifold applications)

6. Methods Of Installation

Dodge Inserts are designed for post mold and molded-in installations.

Post molding is cost effective in that it generally shortens cycle time of the molding process, reduces rejects and damage from inserts that could potentially come loose and damage the mold. Molded-In inserts offer higher torque and pull-out resistance.

Several Dodge insert designs are available for Post-Molding using Ultrasonic installation or Heat installation.

a. Heat Installation

Heat installation involves positioning the insert into the molded or drilled hole. A heated tip is then inserted into the inside diameter of the threaded insert.

Localized melting begins to take place and with the downward pressure, the insert begins to install. Plastic flows into the varying undercuts and knurls.

Benefits of thermal installation include:

- » installation of multiple inserts at a given time
- » ability to install inserts beyond 1/4"
- » superior strength assemblies

b. Ultrasonic Installation

Ultrasonic Installation involves positioning the insert into a molded or drilled hole.

An ultrasonic horn then contacts the insert and begins to vibrate the insert. This vibration creates frictional heat which melts the plastic allowing the horn to lower the insert into position. Once installed to the appropriate depth, the cycle is repeated for the next insert.

c. Self -Tapping/Self Threading, Spred-Lok, Expansion Inserts and Mold-In

Designed for ease of installation. Primarily involves preparing straight holes and driving the insert into place, pressing the insert into place, or pressing and then expanding the insert into place. Minimal tooling is required.

c1. Self Tapping

Economical and easy to install. Provides excellent pull out resistance. Insert design features a cutting edge slot which assists in installation.

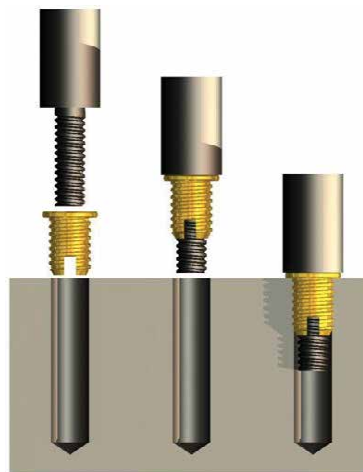

c2. Spred-Lok Inserts

Economical and easy to install. Designed for non-critical applications. Insert is pressed into a straight prepared hole, expansion of the insert is accomplished through the installation of the mating fastener. Mating bolt should be long enough to extend at least two full threads beyond the insert length to ensure insert retention.

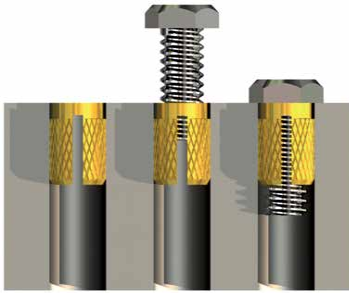

c3. Expansion Inserts

» Standard Expansion

Economical and easy to install. Expansion inserts feature a two piece design consisting of a threaded insert and a captivated spreader plate. The insert is installed into a blind, straight hole and the spreader plate is then depressed. As the spreader plate is engaged, the knurled portion of the insert expands, anchoring the insert into place.

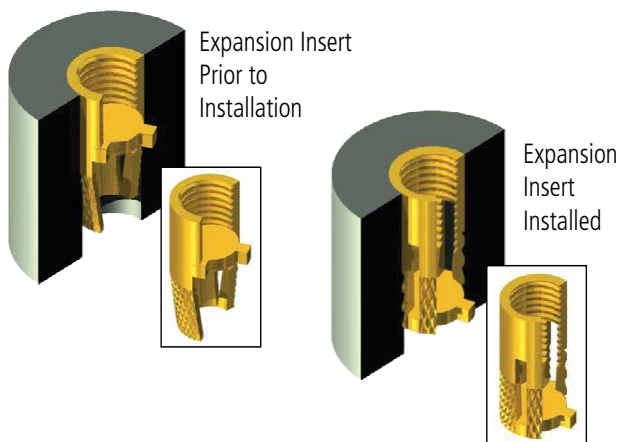

» Clinch Expansion

Clinch inserts feature a pilot and a flange and have the same design characteristics as Standard Expansion Inserts. The inserts are used extensively in the electrical industry. The pilot can be clinched over a terminal connector with the flange providing a large surface for electrical contact. The installation and clinching operations are simultaneous using a simple press-in type tool. Like the Flange Insert, much of the installation force is absorbed by the flange allowing for use in thin-section applications.

» Flange Expansion

The Flange Insert, in addition to having all of the design features of the Standard Insert, has a flange with a large bearing surface. The flange can be used to make an electrical contact or to fasten a terminal connector. The flange can also be used to join mating parts by inserting the body of the insert through the mating part and into the receiving hole in the parent material. The insert is excellent for use in thin section applications since the flange absorbs much of the installation force.

c4. Mold In Inserts

While the trend is to install inserts into Thermoplastics by post mold, some highly filled plastics (above 35% fill) will benefit from a mold-in insert design. The Dodge Ultramold insert is a unique two-piece insert providing full thread to the bottom of the insert. This design also features a controlled minor diameter and innovative counterbore design to insure proper placement on molding pins. This insert design provides optimum strength in a space saving design.

» Ultra-Mold® Inserts

The unique two-piece concept allows full and complete threads throughout the entire length of the insert. This saves space and weight and reduces costs. Below is an image of a conventional insert (on left) and the unique design of the Ultra-Mold (at right).

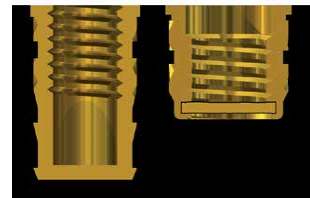

c5. Sealing Inserts

When an insert is heat or ultrasonically installed into a plastic component, the difference in cooling rates of the metal and plastic create a "stress relief zone" or microscopic void between the insert external geometry and the plastic. While this is beneficial in reducing the stress between the two materials, it can pose challenges to those applications requiring a leak-proof interface between the insert and the plastic.

Dodge has addressed this situation with the Ultraseal® insert. The Ultraseal utilizes an O-ring as an integral component of the insert design. When heat installed into the proper geometry hole, the O-ring seals against the plastic and provides a leak-proof assembly.

Applications

Dodge Inserts and Compression Limiters are widely used in critical applications in the automotive, electronics, medical, transportation and general industrial markets.



Aircraft

Threaded Inserts for Plastic Components

In the overhead aircraft interiors, brass inserts are used to strengthen and maintain joint integrity in brittle and soft material extending service life and value.



Automotive

Air Intake Manifold

Using the TaperTuff® and Ultrasert® in the intake manifold allows the OEM to create strong reusable threads that eliminated cracking from bolt load.



Automotive

Grab Handle

Using Compression Limiters eliminates cracking of plastic sub-component automotive interior parts due to bolt loading. The Dodge Compression limiter significantly reduces the warranty and replacement costs.



Automotive

Sunroof Assembly

A key component in the sunroof sub assembly is the power actuating motor. OEM's rely on the Dodge Ultrasert® for mounting the motor to the frame for both stability and high quality.



Electronics

Cell Phone Housing Assembly

Dodge's unique line of Miniature Inserts are used in the Smartphone industry to mate the two plastic outer housings together, resulting in a structural assembly with long service life.



Electronics

GPS Enclosure

GPS Tracking and security devices require consistency and reliability. Manufacturers of GPS assemblies turn to Ultrasert® for quality and reliable fastening every time.



Industrial Appliance

Fan Module

Manufacturers of fan modules around the world depend upon Dodge Ultrasert® brass inserts for reliability and performance.

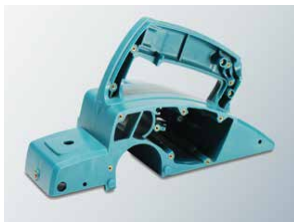

Industrial

Power Tool Housing

Power tool manufacturers count on the Dodge Ultrasert® to provide the superior joint strength, vibration proof properties and high serviceability required of their products.



Industrial

Pump Housing

Multiple Ultrasert® inserts are used in pump assemblies to provide high shear, tensile and torque necessary to handle the load of the fluctuating stresses in the application.



Lawn and Garden

Engine and Component Assembly

In the high vibration world of lawn and garden equipment, the high strength characteristics of the Ultrasert® inserts provide superior retention in brittle and soft materials when fastening plastic components to the engine.



Medical

Medical Device Enclosure

The Dodge Ultrasert® line of threaded inserts are utilized to maintain joint integrity when assembling critical component parts in many types of medical equipment.

Dodge Capabilities

Quality

- » ISO/TS 16949: 2009 certified
- » Lot control ensures product traceability
- » Statistically controlled manufacturing processes
- » PPAP, IMDS, Material Certifications

Sales & Applications Engineers

- » Strategically located throughout North America
- » Offer expertise in insert design, applications engineering and current assembly technologies
- » Offer cost effective fastening solutions; includes:
 - Modifications to our standard products
 - Custom solutions for your specific applications
 - Conduct Line Walks, Value Analysis / Value Engineering

Product Development

- » Our Technical Center offers review of your application, product evaluation, analysis and recommendations to help reduce your assembly costs
- » Development support includes conceptual ideas, preliminary designs and drawings
- » Engineering prototypes and pre-production sampling resources available

Technical Product Seminars

- » Lunch and Learn Seminars offered to engineering, manufacturing, purchasing and quality teams
- » Instructors include representatives from our sales engineering, applications engineering and/or marketing teams

Testing Terminology

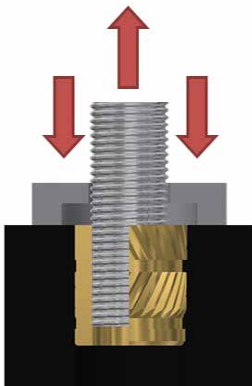

Tensile Strength

Axial force required to pull the insert out of the parent material at least 0.020 inches (0.5mm).

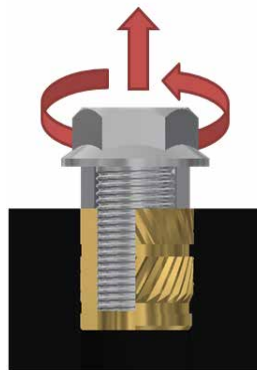

Rotational Torque

Rotational force required to rotate the insert in the parent material. Note that the hardened steel spacer only contacts the insert. It is a good comparative measure of the overall strength of the assembly.

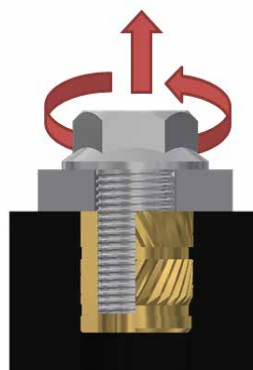

Clampload Torque

Rotational force required to rotate the insert in the parent material. Note that the hardened steel spacer contacts both the parent material and the insert. Mainly used as a strength measure for compression limiters.

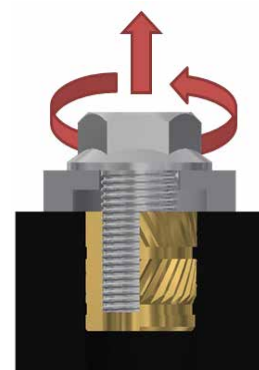

Jack-Out Torque

Rotational force required to pull the insert out of the parent material. Note that the hardened steel spacer only hits the parent material. This will allow both rotational and axial forces to be applied simultaneously. The ultimate test of assembly strength. Results may vary depending on the type of bolt used.

Note: The test data included in this catalogue should be considered as average values for the general families of plastics indicated. Critical application requirements may necessitate further specific testing.

Troubleshooting Guide

Potential Solutions	PROBLEM									
	Insufficient insert strength (pull-out, rotation)	Insert not completely seated	Excessive installation time	Excessive flash on top surface	Excessive flash under insert	Plastic boss bulges or cracks	Welder overloads (cuts out)*	Insert damaged (deformed)	Insert rises above top surface after top installation	Installation too noisy
Increase hole diameter										
Increase hole depth										
Increase boss diameter										
Decrease hole diameter										
Verify plastic melt										
Incorrect fixture design										
Countersink/Counterbore hole										
Increase amplitude*										
Increase pressure										
Increase weldtime										
Decrease downspeed										
Increase hold time										
Decrease pressure										
Decrease amplitude*										
Decrease weld time										
Adjust welder stroke stop										
Pre-trigger/Pre-heat										
Tune power supply										
Tighten horn, booster, or transducer *										
Use more powerful welder										

(*) Refers to Ultrasonic welder only.

If you need further assistance, please contact our Application Engineers, at which time, you will be asked to provide the following information about your application.

- » Company Name / Contact Name
- » Address / Tel. # / Fax # / EMail
- » Distributor or Sales representative
- » Frequency of failure
- » Insert part number
- » Affected quantities
- » Affected lot numbers
- » Hole sizes (tolerances)
- » Tooling information/Method of Installation
- » 25 suspect inserts
- » Sample of application with and without installed inserts



A fluted brass insert designed for ultrasonic or heat installation into thermoplastics.

- » Vertical flutes and horizontal fins provide superior assembly strength
- » Tapered design assures rapid and accurate alignment prior to installation
- » Flute and fin design provide a chip-free environment

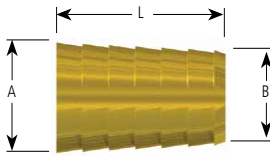
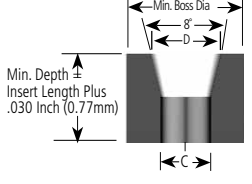
INCH INSERT SPECIFICATIONS					HOLE SIZE RECOMMENDATIONS		
							
Thread Size	Part Number	Length	Diameter		Diameter		Minimum Boss Diameter
		L ± .004	A ± .005	B ± .005	C ± .001	D ± .001	
4-40	70815-04-250	.250	.173	.145	.141	.154	.346
6-32	70815-06-312	.312	.219	.183	.179	.198	.438
8-32	70815-2-375	.375	.252	.212	.206	.227	.504
10-24	70815-3-438	.438	.297	.249	.243	.268	.594
10-32	70811-3-438	.438	.297	.249	.243	.268	.594
1/4-20	70815-4-562	.562	.383	.323	.320	.350	.766
1/4-28	70811-4-562	.562	.383	.323	.320	.350	.766

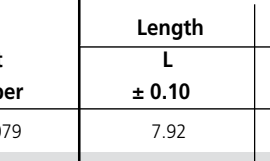
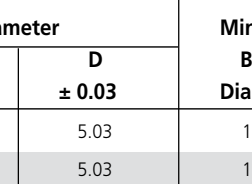
METRIC INSERT SPECIFICATIONS					HOLE SIZE RECOMMENDATIONS		
							
Thread Size	Part Number	Length	Diameter		Diameter		Minimum Boss Diameter
		L ± 0.10	A ± 0.13	B ± 0.13	C ± 0.03	D ± 0.03	
M3x0.5	70817-3-079	7.92	5.56	4.65	4.55	5.03	11.12
M3.5x0.6	70817-3.5-079	7.92	5.56	4.65	4.55	5.03	11.12
M4x0.7	70817-4-095	9.53	6.40	5.38	5.23	5.77	12.80
M5x0.8	70817-5-111	11.13	7.54	6.32	6.17	6.81	15.08
M6x1	70817-6-143	14.27	9.73	8.20	8.13	8.89	19.46

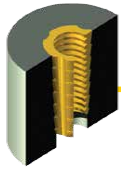

INCH	ABS		POLYCARBONATE		STRUCTURAL FOAM		NYLON 6/6 30% G.F.	
Thread Size	Rotation lbs-in.	Tensile lbs	Rotation lbs-in.	Tensile lbs	Rotation lbs-in.	Tensile lbs	Rotation lbs-in.	Tensile lbs
No. 4	14	251	22 [†]	374	23 [†]	229	23 [†]	295
No. 6	26	309	42	453	44 [†]	441	44 [†]	416
No. 8	42	466	81	843	70	660	84	653
No. 10	62	715	115	1245	116	1005	148	874
1/4"	104	1130	202	1820	206	1802	225	1434

METRIC	ABS		POLYCARBONATE		STRUCTURAL FOAM		NYLON 6/6 30% G.F.	
Thread Size	Rotation Nm	Tensile N	Rotation Nm	Tensile N	Rotation Nm	Tensile N	Rotation Nm	Tensile N
M3	2.94	1375	4.75	2015	5.20	1962	4.97	1850
M3.5	2.94	1375	4.75	2015	5.20	1962	4.97	1850
M4	4.75	2073	9.15	3750	7.91	2936	9.49	2905
M5	7.01	3180	12.99	5538	13.11	4470	16.72	3888
M6	11.75	5026	22.82	8096	23.27	8016	25.42	6316

(†) Screw failed.

Ultraserts

Dodge Ultraserts can be installed using ultrasonic equipment or thermal installation equipment. Thermal equipment can be as simple as a soldering iron held by hand or mounted in an arbor or drill press. More refined equipment is available with adjustments and settings for precise uniform installations.



INCH INSERT SPECIFICATIONS

HOLE SIZE RECOMMENDATIONS

Insert Specifications
0-80, 2-56, M2 and M2.2
Ultrasert II have a single diamond knurl.

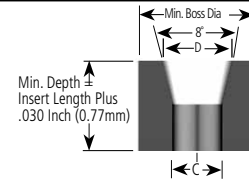
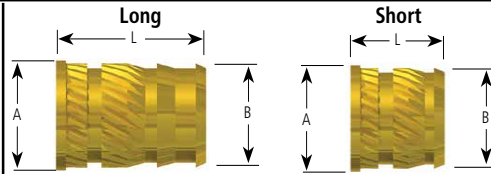

Thread Size	Part Number	Length			Diameter		Diameter		Minimum Boss Diameter
		L ± .004	A ± .005	B ± .005	C ± .001	D ± .001			
0-80	6041-0BR115	.115	.141	.123	.118	.129	.282		
0-80	6041-0BR188	.188	.141	.112	.107	.129	.282		
2-56	6035-02BR115	.115	.141	.123	.118	.129	.282		
2-56	6035-02BR188	.188	.141	.112	.107	.129	.282		
4-40	6035-04BR135	.135	.172	.157	.153	.159	.344		
4-40	6035-04BR219	.219	.172	.146	.141	.159	.344		
6-32	6035-06BR150	.150	.219	.203	.199	.206	.438		
6-32	6035-06BR250	.250	.219	.190	.185	.206	.438		
8-32	6035-2BR185	.185	.250	.230	.226	.234	.500		
8-32	6035-2BR312	.312	.250	.213	.208	.234	.500		
10-24	6035-3BR225	.225	.297	.272	.267	.277	.594		
10-24	6035-3BR375	.375	.297	.251	.246	.277	.594		
10-32	6041-3BR225	.225	.297	.272	.267	.277	.594		
10-32	6041-3BR375	.375	.297	.251	.246	.277	.594		
1/4-20	6035-4BR300	.300	.375	.354	.349	.363	.750		
1/4-20	6035-4BR500	.500	.375	.332	.321	.363	.750		
1/4-28	6041-4BR300	.300	.375	.354	.349	.363	.750		
1/4-28	6041-4BR500	.500	.375	.332	.321	.363	.750		
5/16-18	6035-5BR335	.335	.469	.439	.431	.448	.938		
5/16-18	6035-5BR562	.562	.469	.406	.401	.448	.938		
5/16-24	6041-5BR335	.335	.469	.439	.431	.448	.938		
5/16-24	6041-5BR562	.562	.469	.406	.401	.448	.938		
3/8-16	6035-6BR375	.375	.563	.532	.523	.540	1.126		
3/8-16	6035-6BR625	.625	.563	.493	.488	.540	1.126		
3/8-24	6041-6BR375	.375	.563	.532	.523	.540	1.126		
3/8-24	6041-6BR625	.625	.563	.493	.488	.540	1.126		

METRIC INSERT SPECIFICATIONS

HOLE SIZE RECOMMENDATIONS

Thread Size	Part Number	Length			Diameter		Diameter		Minimum Boss Diameter
		L ± 0.10	A ± 0.13	B ± 0.13	C ± 0.03	D ± 0.03			
M2x0.4	6075-2BR029	2.92	3.58	3.12	3.00	3.28	7.16		
M2x0.4	6075-2BR048	4.78	3.58	2.84	2.72	3.28	7.16		
M2.2x0.45	6075-2.2BR029	2.92	3.58	3.12	3.00	3.28	7.16		
M2.2x0.45	6075-2.2BR048	4.78	3.58	2.84	2.72	3.28	7.16		
M2.5x0.45	6075-2.5BR034	3.43	4.37	3.99	3.89	4.04	8.74		
M2.5x0.45	6075-2.5BR056	5.56	4.37	3.71	3.58	4.04	8.74		
M3x0.5	6075-3BR038	3.80	5.56	5.16	5.05	5.31	11.13		
M3x0.5	6075-3BR064	6.35	5.56	4.83	4.70	5.23	11.13		
M3.5x0.6	6075-3.5BR038	3.81	5.56	5.16	5.05	5.23	11.13		
M3.5x0.6	6075-3.5BR064	6.35	5.56	4.83	4.70	5.23	11.13		
M4x0.7	6075-4BR047	4.70	6.35	5.84	5.74	5.94	12.70		
M4x0.7	6075-4BR079	7.92	6.35	5.41	5.28	5.94	12.70		
M5x0.8	6075-5BR067	6.73	8.33	7.82	7.70	8.00	16.66		
M5x0.8	6075-5BR111	11.13	8.33	7.19	7.06	8.00	16.66		
M6x1	6075-6BR076	7.62	9.52	8.99	8.86	9.22	19.06		
M6x1	6075-6BR127	12.70	9.53	8.43	8.15	9.22	19.06		
M8x1.25	6075-8BR085	8.51	11.91	11.15	10.95	11.38	23.83		
M8x1.25	6075-8BR143	14.27	11.91	10.31	10.19	11.38	23.83		
M10x1.5	6075-10BR095	9.53	14.30	13.51	13.28	13.72	28.60		
M10x1.5	6075-10BR159	15.88	14.30	12.52	12.40	13.72	28.60		



Ultraser® II – Test Data

The most widely accepted and widely used insert in the plastics industry today.

- » Installed ultrasonically or with heat
- » Two lengths allow for increased design flexibility
- » Diagonal knurls and undercuts provide superior assembly strength
- » Excellent design for automated systems

INCH		ABS		POLYCARBONATE		STRUCTURAL FOAM		NYLON 6/6 30% G.F.	
Thread Size	Length	Rotation lbs-in.	Tensile lbs	Rotation lbs-in.	Tensile lbs	Rotation lbs-in.	Tensile lbs	Rotation lbs-in.	Tensile lbs
No. 0	.115	50 oz-in.†	79	52 oz-in.†	135	52 oz-in.†	97	58 oz-in.	96
	.188	65 oz-in.†	162	70 oz-in.†	258	70 oz-in.†	224	65 oz-in.	198
No. 2	.115	67.5 oz-in.	79	110 oz-in.	135	90 oz-in.	97	58 oz-in.	96
	.188	81 oz-in.	162	168 oz-in. †	258	93 oz-in.	224	65 oz-in.	198
No. 4	.135	13	147	20*	230	19	187	20	211
	.219	17	258	23*	417	24	393	21	330
No. 6	.150	23	220	33*	341	29	236	33	286
	.250	25	370	45	661	31	487	34	509
No. 8	.185	37	304	52*	538	32	304	60	355
	.312	45	469	88*	910	50	512	66	883
No. 10	.225	51	448	86	773	55	505	70	565
	.375	68	726	125	1388	72	801	133	1310
1/4"	.300	102	700	157	1283	123	769	132	973
	.500	116	1157	231	2073	131	1171	220	1884
5/16"	.335	155	739	259*	1555	167	932	304	1506
	.562	214	1435	345*	3128	196	1767	428	2654
3/8"	.375	220	940	383	2065	246	1356	420	2040
	.625	229	1743	520	3638	297	2100	518	3303

METRIC		ABS		POLYCARBONATE		STRUCTURAL FOAM		NYLON 6/6 30% G.F.	
Thread Size	Length	Rotation Nm	Tensile N	Rotation Nm	Tensile N	Rotation Nm	Tensile N	Rotation Nm	Tensile N
M2	2.9	0.48	351	0.78	601	0.63	429	0.90	427
	4.8	0.57	721	1.19†	1148	0.66	995	0.90	881
M2.2	2.9	0.48	351	0.78	601	0.63	429	0.90	427
	4.8	0.57	721	1.19†	1148	0.66	995	0.90	881
M2.5	3.4	1.47	654	2.26*	1023	2.23	834	2.26	939
	5.6	1.92	1148	2.60*	1855	2.75	1748	2.37	1468
M3 & M3.5	3.8	2.60	979	3.73*	1517	3.35	1048	3.73	1272
	6.4	2.82	1646	5.08	2940	3.54	2164	3.84	2264
M4	4.7	4.18	1352	5.88	2393	3.56	1350	6.78	1579
	7.9	5.08	2086	9.94*	4048	5.65	2279	7.46	3928
M5	6.7	6.78	2260	10.85	4168	6.25	2723	13.55	3777
	11.1	8.81	3599	15.82	6761	8.08	3903	19.54	7037
M6	7.6	11.52	3114	17.74	5707	13.84	3421	14.91	4328
	12.7	13.11	5147	26.10	9221	14.80	5208	24.86	8380
M8	8.5	17.51	3287	29.26	6917	18.81	4146	34.35	6699
	14.3	24.18	6383	38.98	13914	22.10	7860	48.36	11806
M10	9.5	24.90	4181	43.30	9186	27.80	6032	47.45	9074
	15.9	25.90	7753	58.80	16183	33.60	9341	58.53	14692

(†) Screw failed. (*)Internal thread stripped.



Ultraser® II Screw-Lock

A unique internal locking element that locks the screw in place.

- » Screw-Lock feature has unique locking element for vibration applications
- » Eliminates need for patches, lock washers or locking compounds
- » Ideal for adjusting screw applications

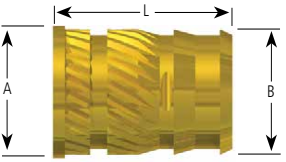
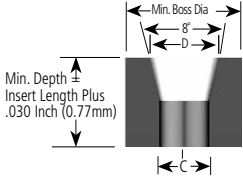
INCH INSERT SPECIFICATIONS					HOLE SIZE RECOMMENDATIONS		
							
Thread Size	Part Number	Length	Diameter		Diameter		Minimum Boss Diameter
		L ± .004	A ± .005	B ± .005	C ± .001	D ± .001	
4-40	6035L-04BR219	.219	.172	.146	.141	.159	.344
6-32	6035L-06BR250	.250	.219	.190	.185	.206	.438
8-32	6035L-2BR312	.312	.250	.213	.208	.234	.500
10-24	6035L-3BR375	.375	.297	.251	.246	.277	.594
10-32	6041L-3BR375	.375	.297	.251	.246	.277	.594
1/4-20	6035L-4BR500	.500	.375	.332	.321	.363	.750
1/4-28	6041L-4BR500	.500	.375	.332	.321	.363	.750

METRIC INSERT SPECIFICATIONS					HOLE SIZE RECOMMENDATIONS		
Thread Size	Part Number	Length	Diameter		Diameter		Minimum Boss Diameter
		L ± 0.10	A ± 0.13	B ± 0.13	C ± 0.03	D ± 0.03	
M2.5x0.45	6075L-2.5BR056	5.56	4.37	3.71	3.58	4.04	8.74
M3x0.5	6075L-3BR064	6.35	5.56	4.83	4.70	5.23	11.13
M3.5x0.6	6075L-3.5BR064	6.35	5.56	4.83	4.70	5.23	11.13
M4x0.7	6075L-4BR079	7.93	6.35	5.41	5.28	5.94	12.70
M5x0.8	6075L-5BR111	11.12	8.33	7.19	7.06	8.00	16.66
M6x1	6075L-6BR127	12.70	9.52	8.43	8.15	9.22	19.06

Note: Assembly and removal are effective up to 5 cycles.

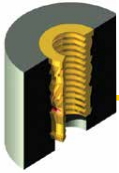

Ultraser[®] II Screw-Lock – Test Data

INCH		ABS		POLYCARBONATE		STRUCTURAL FOAM		NYLON 6/6 30% G.F.		PREVAILING TORQUE**	
Thread Size	Length	Rotation lbs-in.	Tensile lbs	Rotation lbs-in.	Tensile lbs	Rotation lbs-in.	Tensile lbs	Rotation lbs-in.	Tensile lbs	Maximum lbs-in.	Minimum lbs-in.
No. 4	.219	17	258	23*	417	24	393	21	211	92 oz-in.	8.5 oz-in.
No. 6	.250	25	370	45	661	31	487	34	509	192 oz-in.	23.8 oz-in.
No. 8	.312	45	469	88*	910	50	512	66	883	17.3	2.1
No. 10	.375	68	726	125	1388	72	801	133	1310	20.7	3.0
1/4"	.500	116	1157	231	2073	131	1171	220	1884	34.5	6.8

METRIC		ABS		POLYCARBONATE		STRUCTURAL FOAM		NYLON 6/6 30% G.F.		PREVAILING TORQUE**	
Thread Size	Length	Rotation Nm	Tensile N	Rotation Nm	Tensile N	Rotation Nm	Tensile N	Rotation Nm	Tensile N	Maximum Nm	Minimum Nm
M2.5	5.6	1.92	1148	2.60*	1855	2.75	1748	2.37	1468	0.30	0.05
M3	6.4	2.82	1646	5.08	2940	3.54	2164	3.84	2264	0.63	0.09
M3.5	6.4	2.82	1646	5.08	2940	3.54	2164	3.84	2264	0.81	0.12
M4	7.9	5.08	2086	9.94*	4048	5.65	2279	7.46	3928	1.04	0.15
M5	11.1	8.81	3599	15.82	6761	8.08	3903	19.54	7037	1.84	0.27
M6	12.7	13.11	5147	26.10	9221	14.80	5208	24.86	8380	2.76	0.36

(*) Internal thread stripped.

(**) Prevailing torque values are based on the recommended use of cadmium plated screws. Any other type of screw may affect locking torque values and cycles.



Ultraser® III

Symmetrical brass insert designed for high-volume production in ultrasonic, heat or molded in installations.

- » No orientation required and ideal for automated assembly
- » Opposing diagonal knurls provide torque resistance
- » Lead in pilots for rapid and accurate positioning

INCH INSERT SPECIFICATIONS					HOLE SIZE RECOMMENDATIONS	
Insert Specifications 0-80, 2-56; M2x0.4, M2.2x0.45 & M2.5x0.45 Ultraser III have two opposing knurls						
Thread Size	Part Number	Length			Hole Size	
		L ± .004	A ± .004	B ± .003	D + .003 – .000	Minimum Boss Diameter
2-56	6635-02BR157	.157	.135	.123	.128	.286
4-40	6635-04BR226	.226	.179	.154	.158	.358
6-32	6635-06BR281	.281	.220	.185	.189	.440
8-32	6635-2BR321	.321	.250	.218	.222	.500
10-24	6635-3BR375	.375	.281	.249	.253	.562
10-32	6641-3BR375	.375	.281	.249	.253	.562
1/4-20	6635-4BR500	.500	.342	.312	.316	.684
1/4-28	6641-4BR500	.500	.342	.312	.316	.684

METRIC INSERT SPECIFICATIONS					HOLE SIZE RECOMMENDATIONS	
Thread Size	Part Number	Length			Hole Size	
		L ± 0.10	A ± 0.10	B ± 0.08	D + 0.08 – 0.00	Minimum Boss Diameter
M2x0.4	6675-2BR040	3.99	3.43	3.12	3.25	7.26
M2.2x0.45	6675-2.2BR040	3.99	3.43	3.12	3.25	7.26
M2.5x0.45	6675-2.5BR057	5.74	4.55	3.91	4.01	9.09
M3x0.5	6675-3BR057	5.74	4.55	3.91	4.01	9.09
M3.5x0.6	6675-3.5BR071	7.14	5.59	4.70	4.80	11.18
M4x0.7	6675-4BR081	8.15	6.35	5.54	5.64	12.70
M5x0.8	6675-5BR095	9.53	7.14	6.32	6.43	14.27
M6x1	6675-6BR127	12.70	8.69	7.92	8.03	17.37



Ultrasert[®] III – Test Data

INCH	ABS		POLYCARBONATE		STRUCTURAL FOAM		NYLON 6/6 30% G.F.	
Thread Size	Rotation lbs-in.	Tensile lbs	Rotation lbs-in.	Tensile lbs	Rotation lbs-in.	Tensile lbs	Rotation lbs-in.	Tensile lbs
No. 2	7 [†]	81	7 [†]	163	7 [†]	176	8 [†]	166
No. 4	24 [†]	269	24 [†]	297	24 [†]	321	24 [†]	327
No. 6	35	288	44 [†]	548	44 [†]	518	44 [†]	606
No. 8	43	381	75	804	86	607	83	647
No. 10	58	494	120	1006	93	719	146	654
1/4"	143	869	239	1666	230	1240	248	1362

METRIC	ABS		POLYCARBONATE		STRUCTURAL FOAM		NYLON 6/6 30% G.F.	
Thread Size	Rotation Nm	Tensile N	Rotation Nm	Tensile N	Rotation Nm	Tensile N	Rotation Nm	Tensile N
M2 & M2.2	0.79 [†]	360	0.79 [†]	725	0.79 [†]	783	0.90 [†]	738
M2.5 & M3	2.71 [†]	1196	2.71 [†]	1321	2.71 [†]	1428	2.71 [†]	1455
M3.5	3.95	1281	4.97 [†]	2438	4.97 [†]	2304	4.97 [†]	2696
M4	4.86	1695	8.47	3576	9.72	2700	9.38	2878
M5	6.55	2197	13.56	4475	10.51	3198	16.50	2909
M6	16.17	3866	27.00	7411	25.99	5515	28.02	6058

(†) Screw failed.



INCH INSERT SPECIFICATIONS					HOLE SIZE RECOMMENDATIONS	
Thread Size	Part Number	Length	Diameter		Hole Size	Minimum Boss Diameter
		L ± .004	A ± .004	B ± .003	D + .003 – .000	
2-56	UB000256-115	.115	.143	.123	.127	.286
2-56	UB000256	.157	.143	.123	.127	.286
4-40	UB000440-135	.135	.186	.154	.158	.372
4-40	UB000440	.226	.186	.154	.158	.372
6-32	UB000632-150	.150	.217	.185	.189	.434
6-32	UB000632	.281	.217	.185	.189	.434
8-32	UB000832-185	.185	.249	.218	.222	.498
8-32	UB000832	.321	.249	.218	.222	.498
10-24	UB001024-225	.225	.279	.249	.253	.558
10-24	UB001024	.375	.279	.249	.253	.558
10-32	UB001032-225	.225	.279	.249	.253	.558
10-32	UB001032	.375	.279	.249	.253	.558
1/4-20	UB001420-300	.300	.340	.312	.316	.680
1/4-20	UB001420	.500	.340	.312	.316	.680
1/4-28	UB001428-300	.300	.340	.312	.316	.680
1/4-28	UB001428	.500	.340	.312	.316	.680
5/16-18	UB051618-335	.335	.406	.374	.378	.812
5/16-18	UB051618	.500	.406	.374	.378	.812
5/16-24	UB051624-335	.335	.406	.374	.378	.812
5/16-24	UB051624	.500	.406	.374	.378	.812
3/8-16	UB003816-375	.375	.498	.465	.469	.996
3/8-16	UB003816	.500	.498	.465	.469	.996
3/8-24	UB003824-375	.375	.498	.465	.469	.996
3/8-24	UB003824	.500	.498	.465	.469	.996

METRIC INSERT SPECIFICATIONS					HOLE SIZE RECOMMENDATIONS	
Thread Size	Part Number	Length	Diameter		Hole Size	Minimum Boss Diameter
		L ± 0.10	A ± 0.10	B ± 0.08	D + 0.08 – 0.00	
M2x0.4	UBM00204-029	2.92	3.63	3.12	3.23	7.26
M2x0.4	UBM00204	3.99	3.63	3.12	3.23	7.26
M2.2x0.45	UBM22045-029	2.92	3.63	3.12	3.23	7.26
M2.2x0.45	UBM22045	3.99	3.63	3.12	3.23	7.26
M2.5x0.45	UBM25045-034	3.43	4.72	3.91	4.01	9.45
M2.5x0.45	UBM25045	5.74	4.72	3.91	4.01	9.45
M3x0.5	UBM00305-034	3.43	4.72	3.91	4.01	9.45
M3x0.5	UBM00305	5.74	4.72	3.91	4.01	9.45
M3.5x0.6	UBM03506-038	3.81	5.51	4.70	4.80	11.02
M3.5x0.6	UBM03506	7.14	5.51	4.70	4.80	11.02
M4x0.7	UBM00407-047	4.70	6.32	5.54	5.64	12.65
M4x0.7	UBM00407	8.15	6.32	5.54	5.64	12.65
M5x0.8	UBM00508-057	5.72	7.09	6.32	6.43	14.17
M5x0.8	UBM00508	9.53	7.09	6.32	6.43	14.17
M6x1.0	UBM00061-076	7.62	8.64	7.92	8.03	17.27
M6x1.0	UBM00061	12.70	8.64	7.92	8.03	17.27
M8x1.25	UBM08125-085	8.51	10.31	9.50	9.60	20.62
M8x1.25	UBM08125	12.70	10.31	9.50	9.60	20.62
M10x1.5	UBM01015-095	9.53	12.65	11.81	11.91	25.30
M10x1.5	UBM01015	12.70	12.65	11.81	11.91	25.30



Ultrasert[®] IV – Test Data

Parallel-sided brass insert designed for ultrasonic or heat installation into thermoplastics or structural foam materials.

- » Provides high tensile and rotational strength
- » Two lengths allow for design flexibility
- » Lead-in pilot positions insert for installation
- » Parallel sides for installation into straight holes

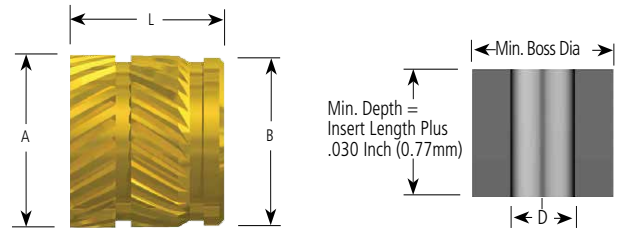

INCH		ABS		POLYCARBONATE		STRUCTURAL FOAM		NYLON 6/6 30% G.F.	
Thread Size	Length	Rotation lbs-in.	Tensile lbs	Rotation lbs-in.	Tensile lbs	Rotation lbs-in.	Tensile lbs	Rotation lbs-in.	Tensile lbs
No. 2	.115	**	**	**	**	**	**	**	**
	.157	6	110	11*	200	10	177	13*	159
No. 4	.135	**	**	**	**	**	**	**	**
	.226	15.8	228	23*	338	23*	329	23*	350
No. 6	.150	**	**	**	**	**	**	**	**
	.281	27	298	45*	598	45*	388	45*	488
No. 8	.185	**	**	**	**	**	**	*	**
	.321	44	440	85*	831	68	567	90	583
No. 10	.225	**	**	**	**	**	**	**	**
	.375	76	622	120*	1026	99	748	139	862
1/4"	.300	**	**	**	**	**	**	**	**
	.500	118	887	210	1717	171	871	213	1100
5/16"	.335	**	**	**	**	**	**	**	**
	.500	168	980	313*	1840	265	1231	316	1618
3/8"	.375	**	**	**	**	**	**	**	**
	.500	336	1334	534	2306	411	1315	663	2938

METRIC		ABS		POLYCARBONATE		STRUCTURAL FOAM		NYLON 6/6 30% G.F.	
Thread Size	Length	Rotation Nm	Tensile N	Rotation Nm	Tensile N	Rotation Nm	Tensile N	Rotation Nm	Tensile N
M2 & M2.2	2.92	**	**	**	**	**	**	**	**
	3.99	.68	489	1.24	890	1.13	787	1.47*	707
M2.5 & M3	3.43	**	**	**	**	**	**	**	**
	5.74	1.79	1014	2.60*	1503	2.60*	1463	2.60*	1557
M3.5	3.81	**	**	**	**	**	**	**	**
	7.14	3.05	1326	5.08*	2660	5.08*	1726	5.08*	2171
M4	4.70	**	**	**	**	**	**	**	**
	8.15	4.97	1957	9.60*	3696	7.68	2522	10.17*	2593
M5	5.72	**	**	**	**	**	**	***	**
	9.53	8.59	2767	13.56	4564	11.19	3327	15.70	3834
M6	7.62	**	**	**	**	**	**	**	**
	12.70	13.33	3946	23.73	7638	19.32	3874	24.07	4893
M8	8.51	**	**	**	**	**	**	**	**
	12.70	18.98	4359	35.36	8185	29.94	5476	35.70	7197
M10	9.53	**	**	**	**	**	**	**	**
	12.70	37.96	5934	60.33	10258	46.44	5849	74.91	13069

(*) Screw failed.

(**) Please contact Applications Engineering for test data.



Ultraser® IV Flanged

INCH INSERT SPECIFICATIONS						HOLE SIZE RECOMMENDATIONS			
Thread Size	Part Number	Length L ± .004	Hole Diameter		Flange Thickness C ± .003	Hole Size D + .003 - .000	Counterbore		Minimum Boss Diameter
			A ± .005	B ± .003			E ± .001	F ± .001	
2-56	UFB000256-133	.133	.188	.123	.018	.127	.204	.022	.286
2-56	UFB000256	.175	.188	.123	.018	.127	.204	.022	.286
4-40	UFB000440-156	.156	.219	.154	.021	.158	.235	.025	.372
4-40	UFB000440	.247	.219	.154	.021	.158	.235	.025	.372
6-32	UFB000632-177	.177	.250	.185	.027	.189	.266	.031	.434
6-32	UFB000632	.308	.250	.185	.027	.189	.266	.031	.434
8-32	UFB000832-218	.218	.281	.218	.033	.222	.297	.037	.498
8-32	UFB000832	.354	.281	.218	.033	.222	.297	.037	.498
10-24	UFB001024-265	.265	.313	.249	.040	.253	.329	.040	.558
10-24	UFB001024	.415	.313	.249	.040	.253	.329	.044	.558
10-32	UFB001032-265	.265	.313	.249	.040	.253	.329	.044	.558
10-32	UFB001032	.415	.313	.249	.040	.253	.329	.044	.558
1/4-20	UFB001420-350	.350	.375	.312	.050	.316	.391	.054	.680
1/4-20	UFB001420	.550	.375	.312	.050	.316	.391	.054	.680
1/4-28	UFB001428-350	.350	.375	.312	.050	.316	.391	.054	.680
1/4-28	UFB001428	.550	.375	.312	.050	.316	.391	.054	.680
5/16-18	UFB051618-385	.385	.438	.374	.050	.378	.454	.054	.812
5/16-18	UFB051618	.550	.438	.374	.050	.378	.454	.054	.812
5/16-24	UFB051624-385	.385	.438	.374	.050	.378	.454	.054	.812
5/16-24	UFB051624	.550	.438	.374	.050	.378	.454	.054	.812
3/8-16	UFB003816-440	.440	.550	.465	.065	.469	.566	.069	.996
3/8-16	UFB003816	.565	.550	.465	.065	.469	.566	.069	.996
3/8-24	UFB003824-440	.440	.550	.465	.065	.469	.566	.069	.996
3/8-24	UFB003824	.565	.550	.465	.065	.469	.566	.069	.996

METRIC INSERT SPECIFICATIONS						HOLE SIZE RECOMMENDATIONS			
Thread Size	Part Number	Length L ± 0.10	Hole Diameter		Flange Thickness C ± 0.08	Hole Size D + 0.08 - 0.00	Counterbore		Minimum Boss Diameter
			A ± 0.13	B ± 0.08			E ± 0.03	F ± 0.03	
M2x0.4	UFBM00204-034	3.38	4.78	3.12	0.48	3.23	5.18	0.56	7.26
M2x0.4	UFBM00204	4.45	4.78	3.12	0.48	3.23	5.18	0.56	7.26
M2.2x0.45	UFBM22045-034	3.38	4.78	3.12	0.48	3.23	5.18	0.56	7.26
M2.2x0.45	UFBM22045	4.45	4.78	3.12	0.48	3.23	5.18	0.56	7.26
M2.5x0.45	UFBM25045-039	3.96	5.56	3.91	0.53	4.01	5.97	0.64	9.45
M2.5x0.45	UFBM25045	6.27	5.56	3.91	0.53	4.01	5.97	0.64	9.45
M3x0.5	UFBM00305-039	3.96	5.56	3.91	0.53	4.01	5.97	0.64	9.45
M3x0.5	UFBM00305	6.27	5.56	3.91	0.53	4.01	5.97	0.64	9.45
M3.5x0.6	UFBM03506-045	4.50	6.35	4.70	0.69	4.80	6.76	0.79	11.02
M3.5x0.6	UFBM03506	7.82	6.35	4.70	0.69	4.80	6.76	0.79	11.02
M4x0.7	UFBM00407-055	5.54	7.14	5.54	0.84	5.64	7.54	0.94	12.65
M4x0.7	UFBM00407	8.99	7.14	5.54	0.84	5.64	7.54	0.94	12.65
M5x0.8	UFBM00508-067	6.73	7.95	6.32	1.02	6.43	8.36	1.12	14.17
M5x0.8	UFBM00508	10.54	7.95	6.32	1.02	6.43	8.36	1.12	14.17
M6x1.0	UFBM00061-089	8.89	9.53	7.92	1.27	8.03	9.93	1.37	17.27
M6x1.0	UFBM00061	13.97	9.53	7.92	1.27	8.03	9.93	1.37	17.27
M8x1.25	UFBM08125-098	9.78	11.13	9.50	1.27	9.60	11.53	1.37	20.62
M8x1.25	UFBM08125	13.97	11.13	9.50	1.27	9.60	11.53	1.37	20.62
M10x1.5	UFBM01015-111	11.18	13.97	11.81	1.65	11.91	14.38	1.75	25.30
M10x1.5	UFBM01015	14.35	13.97	11.81	1.65	11.91	14.38	1.75	25.30



Ultrasert[®] IV Flanged – Test Data

Flange provides a large bearing surface ideal for use in weaker plastics.

- » Ideal for use as an electrical contact or fastening terminal connectors
- » For high strength assemblies; can be used in a reverse screw entry

Test Data From Flange Side

INCH		ABS		POLYCARBONATE		STRUCTURAL FOAM		NYLON 6/6 30% G.F.	
Thread Size	Length	Rotation lbs-in.	Tensile lbs	Rotation lbs-in.	Tensile lbs	Rotation lbs-in.	Tensile lbs	Rotation lbs-in.	Tensile lbs
No. 2	.175	6	110	11	200	10	177	13	159
No. 4	.247	15.8	228	23*	338	23*	329	23*	350
No. 6	.308	27	298	45*	598	45*	388	45*	488
No. 8	.354	44	440	85*	831	68	567	90*	583
No. 10	.415	76	622	120	1026	99	748	139	662
1/4"	.550	118	887	210	1717	171	871	213	1100
5/16"	.550	168	980	313	1840	265	1231	316	1618
3/8"	.565	336	1334	534	2306	411	1315	663	2938

METRIC		ABS		POLYCARBONATE		STRUCTURAL FOAM		NYLON 6/6 30% G.F.	
Thread Size	Length	Rotation Nm	Tensile N	Rotation Nm	Tensile N	Rotation Nm	Tensile N	Rotation Nm	Tensile N
M2 & M2.2	4.45	0.68	489	1.24	890	1.13	787	1.47*	707
M2.5 & M3	6.27	1.79	1014	2.60*	1503	2.60*	1463	2.60*	1557
M3.5	7.82	3.05	1326	5.08*	2660	5.08*	1726	5.08*	2171
M4	8.99	4.97	1957	9.60*	3696	7.68	2522	10.17*	2593
M5	10.54	8.59	2767	13.56	4564	11.19	3327	15.70	3834
M6	13.97	13.33	3946	23.73	7638	19.32	3874	24.07	4893
M8	13.97	18.98	4359	35.36	8185	29.94	5476	35.70	7197
M10	14.35	37.96	5934	60.33	10258	46.44	5849	74.91	13069

Test Data For Loads Applied From Opposite End

INCH		ABS		POLYCARBONATE		STRUCTURAL FOAM		NYLON 6/6 30% G.F.	
Thread Size	Length	Rotation lbs-in.	Tensile lbs	Rotation lbs-in.	Tensile lbs	Rotation lbs-in.	Tensile lbs	Rotation lbs-in.	Tensile lbs
No. 2	.175	6	292	11	359	10	367	13	382
No. 4	.247	15.8	573	23*	827	23*	711	23*	840
No. 6	.308	27	846	45*	1294	46*	966	46*	1329
No. 8	.354	44	1161	85*	1952	68	1310	90*	1939
No. 10	.415	76	1251	120	2159	99	1557	139	2113
1/4"	.550	118	1409	210	2369	171	1800	213	2881
5/16"	.550	168	1759	313	2720	265	2003	316	2925
3/8"	.565	336	2714	534	4904	411	3083	663	5678

METRIC		ABS		POLYCARBONATE		STRUCTURAL FOAM		NYLON 6/6 30% G.F.	
Thread Size	Length	Rotation Nm	Tensile N	Rotation Nm	Tensile N	Rotation Nm	Tensile N	Rotation Nm	Tensile N
M2 & M2.2	4.45	0.68	1299	1.24	1597	1.13	1632	1.47*	1699
M2.5 & M3	6.27	1.79	2549	2.60*	3679	2.60*	3163	2.60*	3737
M3.5	7.82	3.05	3763	5.08*	5756	5.08*	4297	5.08*	5912
M4	8.99	4.97	5164	9.60*	8683	7.68	5827	10.17*	8625
M5	10.54	8.59	5565	13.56	9604	11.19	6976	15.70	9399
M6	13.97	13.33	6268	23.73	10538	19.32	8006	24.07	12815
M8	13.97	18.98	7824	35.36	12099	29.94	8910	35.70	13011
M10	14.35	37.96	12072	60.33	21814	46.44	13714	74.91	25257

(*) Screw failed. Note: Test data is for long lengths only. Please contact Applications Engineering for short length test data.



Innovative Pipe Thread Insert provides a pressure tight seal over a broad range of temperatures.

- » For installation after molding using heat
- » High temperature O-ring provides pressure tight seal
- » Installation temperatures up to 600°F; operating temperature up to 400°F
- » Diagonal knurls and fin profiles exceed rotational and tensile requirements

INCH INSERT SPECIFICATIONS					HOLE SIZE RECOMMENDATIONS			
Thread Size	Part Number	Length L	Diameter A	Diameter B	Diameter C	Diameter D	Length E min	Minimum Boss Diameter
1/8-27	6092-2*BM400	.400	.614	.562	.607	.567	.430	.850
1/4-18	6092-4*BM475	.475	.736	.680	.727	.685	.505	.972
3/8-18	6092-6*BM500	.500	.883	.812	.870	.817	.530	1.119

(*) To order, complete the part number by adding the code letters which correspond to the type of internal thread required from Table 1 below.

Example: For 1/8-27 NPT brass insert, the part number will be 6092-2PTBM400.

Note: O-Ring material is Viton®.

Table 1

Thread Type	Code*
ANPT	AT
NPT	PT
NPTF	TF
NPSI	SI
NPSF	SF
NPSC	SC

Assembly Strength Data

Dodge Ultraseal Pipe Thread Inserts provide high tensile and torque loads in addition to their sealing features. The combination of diagonal knurls and undercuts provide a unique anchoring arrangement.

Average test values are for reference purposes.

Thread Size	Tensile lbs	Rotational Torque lbs-in	Recommended Pressure PSI
1/8-27	526	335	Up to 250
1/4-18	1000	575	Up to 250
3/8-18	1586	950	Up to 250

Material: 30% Glass filled nylon 6/6



For applications where a molded-in design is more economical than post molding.

- » 2 piece design provides full threads through entire length of insert
- » Controlled minor diameter reduces insert movement during molding for accurate alignment
- » Unique counterbore positions insert over molding pin and allows for easy bolt entry
- » Eliminates machine chips and oil residue that could contaminate molded product

INCH STANDARD SPECIFICATIONS

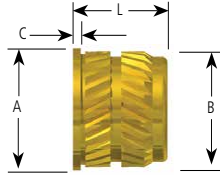

Thread Size	Part Number	Length	Diameter		Flange Thickness	Minimum Boss Diameter
		L ± .008	A ± .005	B ± .005	C ± .005	
8-32	6176-2BA297	.297	.281	.250	.020	.486
10-24	6176-3BA347	.347	.312	.280	.025	.512
10-32	6177-3BA347	.347	.312	.280	.025	.512
1/4-20	6176-4BA442	.442	.375	.340	.030	.576
1/4-28	6177-4BA442	.442	.375	.340	.030	.576
5/16-18	6176-5BA556	.556	.438	.405	.035	.641
5/16-24	6177-5BA556	.556	.438	.405	.035	.641
3/8-16	6176-6BA645	.645	.593	.514	.040	.750
3/8-24	6177-6BA645	.645	.593	.514	.040	.750

METRIC INSERT SPECIFICATIONS

Thread Size	Part Number	Length	Diameter		Flange Thickness	Minimum Boss Diameter
		L ± 0.20	A ± 0.13	B ± 0.13	C ± 0.13	
M4x0.7	6175-4BA075	7.55	7.14	6.35	0.50	12.35
M5x0.8	6175-5BA088	8.82	7.93	7.12	0.64	13.11
M6x1.0	6175-6BA1123	11.23	9.53	8.64	0.77	14.64
M8x1.25	6175-8BA1413	14.13	11.13	10.29	0.89	16.29
M10x1.5	6175-10BA1639	16.39	15.07	13.06	1.020	19.06

Ultra-Mold - Test Data

INCH		ABS		POLYCARBONATE		NYLON 6/6	
Thread Size	Part Number	Rotation lbs-in.	Tensile lbs	Rotation lbs-in.	Tensile lbs	Rotation lbs-in.	Tensile lbs
8-32	6176-2BA297	54	456	69	593	85	813
10-24	6176-3BA347	85	632	107	744	128	1137
10-32	6177-3BA347	85	632	107	744	128	1137
1/4-20	6176-4BA442	170	993	249	1393	230	1454
1/4-28	6177-4BA442	170	993	249	1393	230	1454
5/16-18	6176-5BA556	302	1428	457	2097	389	2957
5/16-24	6177-5BA556	302	1428	457	2097	389	2957
3/8-16	6176-6BA645	538	2138	567	2710	812	4107
3/8-24	6177-6BA645	538	2138	567	2710	812	4107

METRIC		ABS		POLYCARBONATE		NYLON 6/6	
Thread Size	Part Number	Rotation lbs-in.	Tensile lbs	Rotation lbs-in.	Tensile lbs	Rotation lbs-in.	Tensile lbs
M4x0.7	6175-4BA075	6.10	2028	7.80	2638	9.60	3616
M5x0.8	6175-5BA088	9.60	2811	12.15	3311	14.46	5057
M6x1.0	6175-6BA1123	19.21	4417	28.13	6196	25.99	6467
M8x1.25	6175-8BA1413	34.12	6352	51.63	9327	43.95	13153
M10x1.5	6175-10BA1639	60.78	9510	64.06	12054	91.74	18268



Miniature

Designed for electronics applications, miniature inserts are available in symmetrical and flange styles.

- » Designed for straight hole installations
- » No orientation required
- » Flanged insert ideal for electrical contact

Symmetrical Style Insert

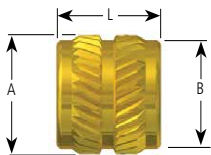
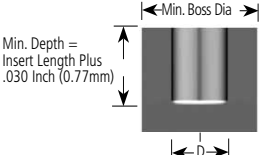
METRIC INSERT SPECIFICATIONS					HOLE SIZE RECOMMENDATIONS	
						
Thread Size	Part Number	Length	Diameter		Diameter	Minimum Boss Diameter
		L ± 0.13	A ± 0.10	B ± 0.08	D + 0.05 – 0.00	
M1.6x0.35	6200-1.6BR030	3.00	2.49	2.06	2.13	4.62

Flanged Style Insert

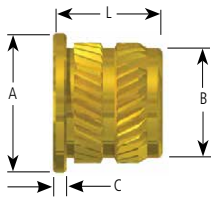
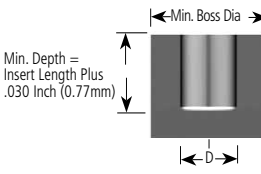
METRIC INSERT SPECIFICATIONS						HOLE SIZE RECOMMENDATIONS	
							
Thread Size	Part Number	Length	Diameter		Flange Thickness	Diameter	Minimum Boss Diameter
		L ± 0.13	A ± 0.13	B ± 0.08	C ± 0.10	D + 0.05 – 0.00	
M1.6x0.35	6201-1.6BR033	3.31	3.18	2.06	0.41	2.14	4.63



Expansion – Standard

Expandable two piece inserts for blind holes in thermoset or thermoplastic materials.

- » Simple, press in application
- » Versatile; can be used in all plastics

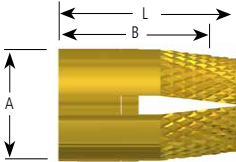
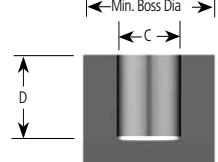
INCH INSERT SPECIFICATIONS					HOLE SIZE RECOMMENDATIONS		
							
Thread Size	Part Number	Installed Length	Body Diameter	Minimum Threaded Length B	Diameter*	Depth	Minimum Boss Diameter
		L ± .004	A ± .003		C ± .001	D Ref.	
4-40	70015-04-250	.250	.156	.178	.158	.250	.312
5-40	70015-05-313	.313	.188	.240	.190	.313	.376
6-32	70015-06-313	.313	.188	.240	.190	.313	.376
6-32	70015-06-375	.375	.188	.303	.190	.375	.376
8-32	70015-2-313	.313	.219	.240	.221	.313	.438
8-32	70015-2-375	.375	.219	.303	.221	.375	.438
10-24	70015-3-375	.375	.250	.303	.252	.375	.500
10-24	70015-3-438	.438	.250	.365	.252	.438	.500
10-32	70011-3-313	.313	.250	.240	.252	.313	.500
10-32	70011-3-375	.375	.250	.303	.252	.375	.500
10-32	70011-3-438	.438	.250	.365	.252	.437	.500
1/4-20	70015-4-500	.500	.313	.428	.315	.500	.626
5/16-18	70015-5-625	.625	.438	.537	.440	.625	.876

METRIC INSERT SPECIFICATIONS					HOLE SIZE RECOMMENDATIONS		
Thread Size	Part Number	Installed Length	Body Diameter	Minimum Threaded Length B	Diameter*	Depth	Minimum Boss Diameter
		L ± 0.10	A ± 0.08		C ± 0.03	D Ref.	
M3x0.5	70017-3-064	6.35	3.97	4.52	4.01	6.40	7.92
M3.5x0.6	70017-3.5-080	7.96	4.78	6.10	4.83	8.00	9.56
M4x0.7	70017-4-080	7.96	5.56	6.10	5.61	8.00	11.13
M4x0.7	70017-4-095	9.53	5.56	7.70	5.61	9.50	11.13
M5x0.8	70017-5-080	8.00	6.35	6.10	6.40	8.00	12.70
M5x0.8	70017-5-095	9.53	6.35	7.70	6.40	9.50	12.70
M6x1	70017-6-127	12.70	7.96	10.87	8.00	12.70	15.90

(*) Diameter "C" is for Thermoset Plastics. For Thermoplastic materials, refer to page 29.

Expansion Insert – Test Data**

EXPANSION INSERTS			ABS		POLYCARBONATE		PHENOLIC	
Inch Size	Metric Size	Insert Length	Rotation lbs-in.	Tensile lbs	Rotation lbs-in.	Tensile lbs	Rotation lbs-in.	Tensile lbs
No. 4	M2.5	.250	13	105	24**	215	24**	171
No. 5	—	.313	21	181	31	239	35**	196
No. 6	M3 & M3.5	.375	22	173	34	231	41**	199
No. 8	M4	.375	44	257	54	317	73**	318
No. 10	M5	.438	55	342	81	354	93	364
1/4	M6	.500	88	436	101	465	97	497
5/16	—	.625	105	606	133	699	110	600

(**) To achieve maximum strength, spreader plate must be pushed to the bottom of the hole. See page 29.

Note: Test data applies to all types of expansion inserts of comparable length.



INCH INSERT SPECIFICATIONS								HOLE SIZE RECOMMENDATIONS		
Thread Size	Part Number	Installed Length	Body Diameter	Minimum Threaded Length	Clinch Height	Flange Diameter	Clinch O.D.	Diameter*	Depth	Minimum Boss Diameter
		L ± .004	A ± .003	B	C ± .006	D ± .003	E ± .002	F ± .001	G Ref.	
4-40	70515-04A250	.250	.156	.178	.046	.219	.138	.158	.220	.312
4-40	70515-04B226	.226	.156	.154	.070	.219	.138	.158	.196	.312
6-32	70515-06A313	.313	.188	.240	.046	.2495	.164	.190	.283	.376
6-32	70515-06B289	.288	.188	.216	.070	.2495	.164	.190	.259	.376
8-32	70515-2A375	.375	.219	.303	.046	.281	.190	.221	.345	.436
8-32	70515-2B351	.351	.219	.279	.070	.281	.190	.221	.321	.436

METRIC INSERT SPECIFICATIONS								HOLE SIZE RECOMMENDATIONS		
Thread Size	Part Number	Installed Length	Body Diameter	Minimum Threaded Length	Clinch Height	Flange Diameter	Clinch O.D.	Diameter*	Depth	Minimum Boss Diameter
		L ± 0.10	A ± 0.08	B	C ± 0.15	D ± 0.08	E ± 0.05	F ± 0.03	G Ref.	
M3x0.5	70517-3A064	6.35	3.97	4.52	1.15	5.57	4.02	4.01	5.59	7.92
M3.5x0.6	70517-3.5A080	7.96	4.78	6.10	1.15	6.34	4.50	4.83	7.19	9.55
M4x0.7	70517-4A095	9.53	5.57	7.70	1.15	7.14	5.00	5.61	8.76	11.13

(*)Diameter "F" is for Thermoset Plastics. For Thermoplastic materials, refer to page 29.

Expansion Tooling

INCH EXPANSION INSERT TOOLING			
Inch Size	Semi Automatic	Clinch Tool	Hand Tool*
No. 4	79005-04	79035-04	79015-04***
No. 5	79005-05	—	79015-05***
No. 6	79005-06	79035-06	79015-06***
No. 8	79005-2	79035-2	79015-2***
No. 10	79005-3	—	79015-3***
1/4"	79005-4	—	79015-4***
5/16"	79005-5	—	79015-5***

*The length of the insert being used must be included in the hand tool part number.

METRIC EXPANSION INSERT TOOLING			
Metric Size	Semi Automatic	Clinch Tool	Hand Tool*
M3	79027-3	79047-3	79017-3***
M3.5	79027-3.5	79047-3.5	79017-3.5***
M4	79027-4	79047-4	79017-4***
M5	79027-5	—	79017-5***
M6	79027-6	—	79017-6***

*The length of the insert being used must be included in the hand tool part number.

Semi-Automatic Model

Used to install Dodge Standard, Flange, and Wedge Inserts. The tool consists of a spring-loaded punch and sleeve. Must be chucked in an arbor press or foot press. Not designed to be driven by a hammer. Basic part number is 79005 for inch and 79027 for metric.



Hand Tool Model

Used to install Dodge Standard, Flange, and Wedge Inserts. Tool may be used with hammer or chuck in an arbor press or foot press. Basic part number is 79015 for inch and 79017 for metric.



Clinch Model

Designed to install and crimp Dodge Clinch Inserts. The tool consists of a punch and a spring-loaded sleeve with a radius section which crimps the eyelet portion of the insert over the mating component. It must be chucked in an arbor press or foot press. Basic part number is 79035 for inch and 79047 for metric.





Expansion – Flanged

INCH INSERT SPECIFICATIONS						HOLE SIZE RECOMMENDATIONS				
Thread Size	Part Number	Installed Length	Body Diameter	Minimum Threaded Length	Flange Diameter	Diameter*	Depth	Counterbore		Minimum Boss Diameter
		L ± .004	A ± .003	B	C ± .003			D ± .001	E Ref.	
4-40	70315-04-219	.219	.156	.146	.219	.158	.219	.234	.034	.312
6-32	70315-06-281	.281	.188	.209	.250	.190	.281	.296	.034	.376
8-32	70315-2-281	.281	.219	.209	.281	.221	.281	.296	.034	.438
10-24	70315-3-313	.313	.250	.240	.313	.252	.313	.328	.034	.502
10-32	70311-3-313	.313	.250	.240	.313	.252	.313	.328	.034	.502
1/4-20	70315-4-438	.438	.313	.365	.406	.315	.438	.453	.034	.626

METRIC INSERT SPECIFICATIONS						HOLE SIZE RECOMMENDATIONS				
Thread Size	Part Number	Installed Length	Body Diameter	Minimum Threaded Length	Flange Diameter	Diameter*	Depth	Counterbore		Minimum Boss Diameter
		L ± 0.10	A ± 0.08	B	C ± 0.08			D ± 0.03	E Ref.	
M3x0.5	70317-3-056	5.56	3.96	3.71	5.54	4.01	5.60	5.92	0.86	7.92
M3.5x0.6	70317-3.5-071	7.14	4.78	5.31	6.35	4.83	7.10	6.71	0.86	9.56
M4x0.7	70317-4-071	7.14	5.54	5.31	7.14	5.61	7.10	7.49	0.86	11.13
M5x0.8	70317-5-080	7.95	6.35	6.10	7.93	6.40	8.00	8.31	0.86	12.70
M6x1	70317-6-111	11.13	7.93	9.27	10.32	8.00	11.10	10.67	0.86	15.90

(*)Diameter "D" is for Thermoset Plastics. For Thermoplastic materials, see below.

Expansion Principle

These inserts are two piece units consisting of threaded insert and a captivated spreader plate. When this spreader plate is depressed, the knurled portion of the insert expands and anchors the insert in the hole.

Expansion inserts must be expanded by depressing the spreader plate prior to insertion of the screw. The screw will not depress the spreader plate.

The Expansion Inserting Tooling shown on page 28 provides an economical and efficient means of installing the inserts.

The Dodge hand tool works best in thermoset materials. Since the receiving hole diameter is .002 inch larger than the insert diameter, the insert drops freely into the hole and is ready to be expanded using this tool.

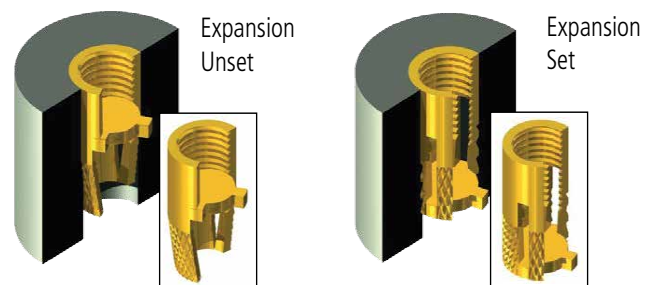

Installation Guidelines

For thermoplastic materials, the receiving hole diameter is .003 inch (0.076 mm) smaller than the insert diameter.

Because there is interference, the insert must be pressed to the bottom of the hole prior to expanding it. The shoulder on the tool installs the insert. Once it has bottomed, tension on an internal spring is overcome and the punch depresses the spreader plate permanently anchoring the insert in the hole.

DO NOT push the spreader plate too deep. This will reduce the holding strength of the insert significantly.

Self Threading



Economical, easy to use insert for adding a thread to a variety of plastics.

- » Installs easily into thermoplastics
- » Slots provide rapid cutting action
- » Flanged style provides larger bearing surface

INCH INSERT SPECIFICATIONS					HOLE SIZE RECOMMENDATIONS					
Thread Size	Part Number	Length	Body Diameter	Pilot Diameter	Hole Diameter		Hole Depth	Counterbore		Minimum Boss Diameter
		L ± .010	A ± .006	B ± .010	C Thermoset	C Thermoplastic	D Ref.	E ± .001	F Ref.	
2-56	ST086-56	.187	.140	.122	.129/.127	.124/.127	.225	.141	.032	.280
4-40	ST112-40	.234	.171	.132	.156/.152	.149/.152	.281	.172	.042	.342
6-32	ST138-32	.281	.217	.170	.198/.194	.190/.194	.337	.219	.050	.434
8-32	ST164-32	.328	.248	.195	.230/.226	.222/.226	.394	.250	.050	.496
10-24	ST190-24	.375	.296	.232	.270/.264	.259/.264	.450	.270	.056	.592
10-32	ST190-32	.375	.296	.232	.270/.264	.259/.264	.450	.270	.056	.592
1/4-20	ST250-20	.484	.374	.302	.343/.336	.330/.336	.581	.375	.063	.748
1/4-28	ST250-28	.484	.374	.302	.343/.336	.330/.336	.581	.375	.063	.748

METRIC INSERT SPECIFICATIONS					HOLE SIZE RECOMMENDATIONS					
Thread Size	Part Number	Length	Body Diameter	Pilot Diameter	Hole Diameter		Hole Depth	Counterbore		Minimum Boss Diameter
		L ± 0.25	A ± 0.15	B ± 0.25	C Thermoset	C Thermoplastic	D Ref.	E ± 0.03	F Ref.	
M2x0.4	STM2x0.4	4.75	3.56	3.10	3.28/3.23	3.17/3.24	5.71	3.58	0.81	7.11
M2.2x0.45	STM2.2x0.45	4.75	3.56	3.10	3.28/3.23	3.17/3.24	5.71	3.58	0.81	7.11
M2.5x0.45	STM2.5x0.45	5.94	4.34	3.35	3.96/3.86	3.78/3.86	7.14	4.37	1.07	8.70
M3x0.5	STM3x0.5	7.14	5.51	4.32	5.03/4.93	4.83/4.93	8.56	5.56	1.27	11.02
M3.5x0.6	STM3.5x0.6	7.14	5.51	4.32	5.03/4.93	4.83/4.93	8.56	5.56	1.27	11.02
M4x0.7	STM4x0.7	8.33	6.30	4.95	5.84/5.74	5.63/5.74	10.01	6.35	1.27	12.60
M5x0.8	STM5x0.8	9.52	7.52	5.89	6.86/6.71	6.58/6.71	11.43	6.89	1.42	15.04
M6x1	STM6x1	12.29	9.50	7.67	8.71/8.53	8.38/8.58	14.76	9.53	1.60	19.00

Self Threading Tooling

INCH SELF THREADING TOOLING			
Inch Size	Standard Inserting Tool Part No.	Extension Inserting Tool Part No.	Hand Inserting Tool Part No.
2-56	5301-02	5301-02-15	5311-02
4-40	5301-04	5301-04-15	5311-04
6-32	5301-06	5301-06-15	5311-06
8-32	5301-2	5301-2-15	5311-2
10-24	5301-3	5301-3-15	5311-3
10-32	5302-3	5302-3-15	5312-3
1/4-20	5301-4	5301-4-15	5311-4
1/4-28	5302-4	5302-4-15	5312-4

METRIC SELF THREADING TOOLING			
Inch Size	Standard Inserting Tool Part No.	Extension Inserting Tool Part No.	Hand Inserting Tool Part No.
M2x0.4	5370-2	5370-2-15	5380-2
M2.2x0.45	5370-2.2	5370-2.2-15	5380-2.2
M2.5x0.45	5370-2.5	5370-2.5-15	5380-2.5
M3x0.5	5370-3	5370-3-15	5380-3
M3.5x0.6	5370-3.5	5370-3.5-15	5380-3.5
M4x0.7	5370-4	5370-4-15	5380-4
M5x0.8	5370-5	5370-5-15	5380-5
M6x1	5370-6	5370-6-15	5380-6

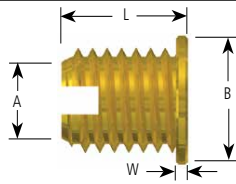
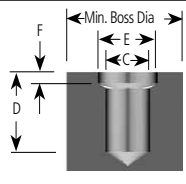

Self Threading – Flanged

INCH INSERT SPECIFICATIONS						HOLE SIZE RECOMMENDATIONS				
										
Thread Size	Part Number	Length	Pilot Diameter	Flange Diameter	Flange Thickness	Hole Diameter		Hole Depth	Counterbore	
		L ± .010	A ± .010	B ± .005	W ± .005	C Thermoset	C Thermoplastic	D Ref.	E ± .001	F Ref.
2-56	STF086-56	.228	.122	.186	.020	.129-.127	.127-.124	.266	.141	.032
4-40	STF112-40	.298	.132	.218	.025	.156-.152	.152-.149	.345	.172	.042
6-32	STF138-32	.355	.170	.250	.030	.198-.194	.194-.190	.412	.219	.050
8-32	STF164-32	.360	.195	.281	.035	.230-.226	.226-.222	.426	.250	.050
10-24	STF190-24	.404	.232	.375	.040	.270-.264	.264-.259	.480	.270	.056
10-32	STF190-32	.404	.232	.375	.040	.270-.264	.264-.259	.480	.270	.056
1/4-20	STF250-20	.460	.302	.438	.050	.343-.336	.336-.330	.557	.375	.063
1/4-28	STF250-28	.460	.302	.438	.050	.343-.336	.336-.330	.557	.375	.063

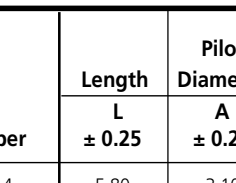
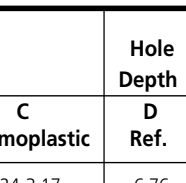
METRIC INSERT SPECIFICATIONS						HOLE SIZE RECOMMENDATIONS				
										
Thread Size	Part Number	Length	Pilot Diameter	Flange Diameter	Flange Thickness	Hole Diameter		Hole Depth	Counterbore	
		L ± 0.25	A ± 0.25	B ± 0.13	W ± 0.10	C Thermoset	C Thermoplastic	D Ref.	E ± 0.03	F Ref.
M2x0.4	STFM2x0.4	5.80	3.10	4.72	0.51	3.28-3.23	3.24-3.17	6.76	3.58	0.81
M2.2x0.45	STFM2.2x0.45	5.80	3.10	4.72	0.51	3.28-3.23	3.24-3.17	6.76	3.58	0.81
M2.5x0.45	STFM2.5x0.45	7.57	3.35	5.54	0.64	3.96-3.86	3.86-3.78	8.76	4.37	1.07
M3x0.5	STFM3x0.5	9.02	4.32	6.35	0.76	5.03-4.93	4.93-4.83	10.46	5.56	1.27
M3.5x0.6	STFM3.5x0.6	9.02	4.32	6.35	0.76	5.03-4.93	4.93-4.83	10.46	5.56	1.27
M4x0.7	STFM4x0.7	9.15	4.95	7.14	0.89	5.84-5.74	5.74-5.63	10.82	6.35	1.27
M5x0.8	STFM5x0.8	10.27	5.89	9.53	1.02	6.86-6.71	6.71-6.58	12.19	6.86	1.42
M6x1	STFM6x1	11.69	7.67	11.13	1.27	8.71-8.53	8.58-8.38	14.15	9.53	1.60

Self Threading Tools



Hand Inserting Tool

The basic self-threading installation tool which allows for simple installation of self-threading inserts utilizing a tap handle.



Standard Inserting Tool

The simple clutch feature allows the insert to break free from the installation tool after assembly.



Extension Inserting Tool

The extension tool provides an additional 5/8" to 1-1/2" extension (depending on thread size) over the standard Inserting tool.

Note: See Tooling charts on previous page.



Economical alternative style allows for repeatable thread used in most plastics.

- » Fast and easy press-in installation
- » Screw expands insert locking into place

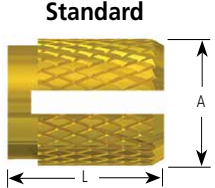
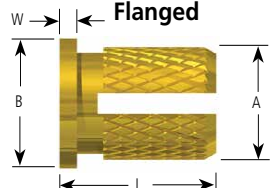
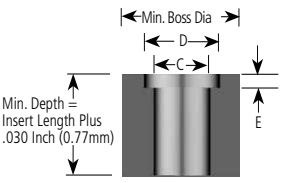
STANDARD INCH INSERT SPECIFICATIONS				HOLE SIZE RECOMMENDATIONS	
					
Thread Size	Part Number	Length	Diameter	Hole Size	Minimum Boss Diameter
		L ± .004	A ± .005		
4-40	74115-04	.188	.166	.156	.332
6-32	74115-06	.250	.199	.188	.398
8-32	74115-2	.313	.230	.219	.460
10-24	74115-3	.375	.262	.250	.524
10-32	74111-3	.375	.262	.250	.524
1/4-20	74115-4	.500	.326	.313	.652

STANDARD METRIC INSERT SPECIFICATIONS				HOLE SIZE RECOMMENDATIONS	
Thread Size	Part Number	Length	Diameter	Hole Size	Minimum Boss Diameter
		L ± 0.10	A ± 0.13		
M3x0.5	74117-3	4.78	4.22	3.96	8.43
M3.5x0.6	74117-3.5	6.35	5.05	4.78	10.11
M4x0.7	74117-4	7.95	5.84	5.56	11.68
M5x0.8	74117-5	9.53	6.65	6.35	13.31
M6x1	74117-6	12.70	8.28	7.95	16.56

FLANGED INCH INSERT SPECIFICATIONS						HOLE SIZE RECOMMENDATIONS			
Thread Size	Part Number	Length	Hole Diameter	Flange Diameter	Flange Width	Hole Size	Counterbore		Minimum Boss Diameter
							Diameter	Depth	
		L ± .004	A ± .005	B ± .005	W ± .004		C ± .001	D ± .001	
4-40	74215-04	.188	.166	.219	.022	.156	.235	.027	.332
6-32	74215-06	.250	.199	.250	.028	.188	.266	.033	.398
8-32	74215-2	.313	.230	.281	.035	.219	.297	.040	.460
10-24	74215-3	.375	.262	.313	.043	.250	.329	.048	.524
10-32	74211-3	.375	.262	.313	.043	.250	.329	.048	.524
1/4-20	74215-4	.500	.326	.375	.050	.313	.391	.055	.652

FLANGED METRIC INSERT SPECIFICATIONS						HOLE SIZE RECOMMENDATIONS			
Thread Size	Part Number	Length	Hole Diameter	Flange Diameter	Flange Width	Hole Size	Counterbore		Minimum Boss Diameter
							Diameter	Depth	
		L ± 0.10	A ± 0.13	B ± 0.13	W ± 0.10		C ± 0.03	D ± 0.03	
M3x0.5	74217-3	4.78	4.22	5.56	.56	3.96	5.97	.69	8.43
M3.5x0.6	74217-3.5	6.35	5.05	6.35	.71	4.78	6.76	.84	10.11
M4x0.7	74217-4	7.95	5.84	7.14	.89	5.56	7.54	1.02	11.68
M5x0.8	74217-5	9.53	6.65	7.95	1.09	6.35	8.36	1.22	13.31
M6x1	74217-6	12.70	8.28	9.53	1.27	7.95	9.93	1.40	16.56



Tapered style is ideal for easy installation into thermoplastics.

- » Entire length of insert is in contact with hole during installation
- » Tapered hole is required and easier to mold
- » Mold design is simplified and molding costs decreased

INCH INSERT SPECIFICATIONS					HOLE SIZE RECOMMENDATIONS	
Thread Size	Part Number	Length	Diameters		Diameter	Minimum Boss Diameter
		L ± .005	A ± .004	B ± .004	C + .002	
2-56	500256-197	.197	.165	0.144	0.151	0.268
4-40	500440-197	.197	.165	0.144	0.151	0.268
6-32	500632-236	0.236	.220	0.192	0.206	0.346
8-32	500832-236	0.236	.235	0.201	0.230	0.385
8-32	500832-295	0.295	.235	0.201	0.230	0.385
10-24	501024-275	0.275	0.281	0.242	0.273	0.429
10-24	501024-354	0.354	0.281	0.242	0.273	0.429
10-32	501032-275	0.275	0.281	0.242	0.273	0.429
10-32	501032-354	0.354	0.281	0.242	0.273	0.429
1/4-20	501420-354	0.354	0.338	0.301	0.336	0.531
1/4-20	501420-393	0.393	0.338	0.301	0.336	0.531
1/4-28	501420-354	0.354	0.338	0.301	0.336	0.531
1/4-28	501420-393	0.393	0.338	0.301	0.336	0.531
5/16-18	551618-472	0.472	0.444	0.377	0.431	0.665
5/16-24	551624-472	0.472	0.444	0.377	0.431	0.665

METRIC INSERT SPECIFICATIONS					HOLE SIZE RECOMMENDATIONS	
Thread Size	Part Number	Length	Diameters		Diameter	Minimum Boss Diameter
		L ± 0.13	A ± 0.13	B ± 0.10	C ± 0.05	
M2x0.4	500204-5	5.00	4.19	3.66	3.85	6.80
M2.5x0.45	525045-5	5.00	4.19	3.66	3.85	6.80
M3x0.5	500305-5	5.00	4.78	4.10	4.45	8.00
M3x0.5	500305-55	5.50	4.78	4.10	4.45	8.00
M3.5x0.6	503506-6	6.00	5.59	4.88	5.25	8.80
M4x0.7	500407-6	6.00	5.97	5.12	5.85	9.80
M4x0.7	500407-75	7.50	5.97	5.12	5.85	9.80
M5x0.8	500508-7	7.00	7.15	6.15	6.95	10.90
M5x0.8	500508-9	9.00	7.15	6.15	6.95	10.90
M6x1	500061-9	9.00	8.60	7.65	8.55	13.50
M6x1	500061-10	10.00	8.60	7.65	8.55	13.50
M8x1.25	508125-12	12.00	11.30	9.60	10.95	16.90

Compression Limiters

Compression Limiters are non-threaded bushings that will support the load of the threaded fastener and will prevent the plastic material from cracking. All limiters are custom designed for each application.

Applications

Dodge offers compression limiters for applications where the tightening load of the bolt or screw could potentially compress, crack or otherwise damage the plastic component.

Typical Markets for Compression Limiters:

- » Automotive
- » Agriculture
- » Aerospace
- » Appliance/ White goods
- » Consumer Products
- » Electronics
- » Medical etc.

Materials and Types

Compression Limiters can be made of various materials – brass, aluminum or steel. Limiters are designed with various knurl configurations and undercuts to meet the strength requirements of your specific application.

Methods of Installation

These inserts can be installed with heat or ultrasonic, or they can be pressed into place.

Engineering

Our Dodge Applications Engineering Team is available and ready to assist you in the design and development of the optimum bushing for your application. We can also provide sample parts and test data to support your design efforts.

If you are considering utilizing Compression Limiters in your design, the following Engineering Data will be required for Application Development:

- » Installation Method
- » Material Type
- » Tightening Torque Required
- » Bolt Size
- » Material Thickness
- » Maximum Hole Size (Clearance for Bolt)
- » Flange or No Flange
- » Sealing or Non Sealing Application

STANLEY Engineered Fastening Applications Engineers will utilize this data to search our database of existing Compression Limiters designs.

If a custom design is necessary, this information will allow STANLEY Engineered Fastening to design a specific Compression Limiter for your application.



Powerful Brands. Breakthrough Solutions.

At STANLEY Engineered Fastening we believe in seeking ways to serve our customers better. We create the future by anticipating our customers needs. Through diversifying our product lines, creating unique assembly technologies and offering a breadth of service to meet the demands of industry worldwide, STANLEY Engineered Fastening provides technological solutions to over 100 different industries.



Avdel®

Avdel® has been producing assembly systems since 1936 and offers a comprehensive range of fasteners and tooling.



POP®

From 2mm micro rivets to 1/4" structural rivets, POP blind rivets meet the needs of multiple markets.



Dodge®

With a focus on high-quality threaded inserts for plastics products, Dodge has been a leader in the fastening market since the 1950s.



STANLEY Assembly Technologies

STANLEY Assembly Technologies supplies production solutions to the global assembly market.



Gripco®

Gripco® has been providing quality nut and threaded assembled products since 1904.



Spirallock®

Spirallock is a technologically superior fastening system ideally suited for threaded joint applications subjected to heavy shock and vibration.



Heli-Coil®

Based on a long history that began in the aerospace industry, Heli-Coil offers a vast range of high-quality.



Tucker®

A one-sided drawn-arc welding process is the foundation of the Tucker No-Hole assembly solution.



iForm®

iForm® continues a proud heritage since 1969 and represents over 40 years of creative threaded fastener application engineering.



Warren®

Whether it's plastic, metal, or a combination of the two, Warren can design a product that will suit your environment.

STANLEY®

Engineered Fastening



STANLEY Engineered Fastening, a Stanley Black & Decker Inc. Company has been revolutionizing fastening and assembly technologies for a variety of industries for more than 40 years.

For more information, please visit our website
www.StanleyEngineeredFastening.com

Quick Links:

- ▶ Our locations
<http://www.stanleyengineeredfastening.com/contact/global-locations>
- ▶ Request Information
<http://www.stanleyengineeredfastening.com/econtact/request-information>
- ▶ Resource Center
<http://www.stanleyengineeredfastening.com/resource-center>



© 2015 Stanley Black & Decker, Inc., D4100, Rev. F 12.2015

Dodge®, Ultrasert®, Ultraseal®, Ultra-Mold® and TaperTuff® are registered trademarks of Stanley Black & Decker, Inc. and its affiliates. Viton® is a registered trademark of The Chemours Company FC, LLC.

Data shown
to be consid



Get quote »

nuous product del
ing representative

Angic Global Solutions

<https://www.AngicGlobal.com> Sales@AngicGlobal.com

1-888-872-0690

atalog is not
on.